

SPIRIT[®] YACHTS

BY GLASTRON

owner's manual

Rules of the Road

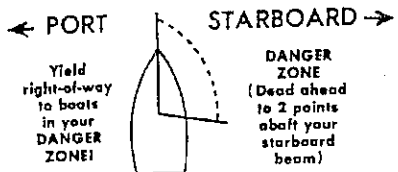

REMEMBER THESE RULES

- OVERTAKING-PASSING:** Boat being passed has the right-of-way. **KEEP CLEAR.**
- MEETING HEAD ON:** Keep to the right.
- CROSSING:** Boat on right has the right-of-way. Slow down and permit him to pass.

WHISTLE SIGNALS

- ONE LONG BLAST:** Warning signal (Coming out of slip)
- ONE SHORT BLAST:** Pass on my port side
- TWO SHORT BLASTS:** Pass on my starboard
- THREE SHORT BLASTS:** Engines in reverse
- FOUR OR MORE BLASTS:** Danger signal

STORM WARNINGS

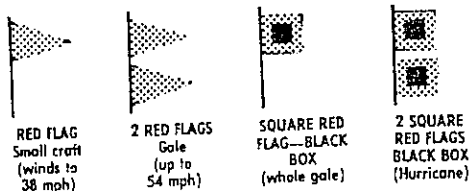

CHANNEL BUOY GUIDE

Entering port or going upstream

PORT SIDE

Color: Black
odd numbers

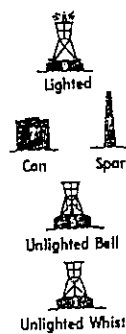

MID-CHANNEL

Color: Black & White
no numbers

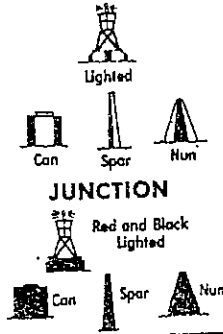

STARBOARD

Color: Red
even numbers



JUNCTION

Red and Black Lighted

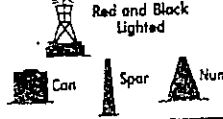

USE COMMON SENSE AFLOAT



SPIRIT YACHTS by Glastron

SPIRIT YACHTS

TABLE OF CONTENTS

U.S. Coast Guard Requirements	3
Boat Specifications	5
Rigging Checklist	7

Section I: OPERATION

A. Before Launch	8
B. Rigging Procedure S-23 & S-6.5	8
C. Rigging Procedure S-28	12
D. Underway	14
E. Tuning the Mast	15
F. Setting & Trimming the Mainsail	15
G. Reefing Procedure	18
H. Setting & Trimming Genoa and Jibs	18
I. Setting & Trimming the Spinnaker	20
J. Reefing the Genoa	22
K. Pop Top Operating Instructions	23
L. Kick Up Rudder Operating Instructions	24

Section II: BOATING SKILLS

A. Basic Rules	26
B. Charts	27
C. Accessory Equipment Required	28
D. Recommended Additional Gear	29
E. What Sail to Add First	30
F. What About Cloth Weight	30
G. Tying A Bowline	31

Section III: SYSTEMS

A. S-6.5, S-23 CB & S-23 K	
1. Water	33
2. Electrical	33
3. Folding Berth	34
4. Winches (Not on S-23 K)	34

(Cont.)

Due to continuing improvements and changes in SPIRIT YACHTS product features and options, the items discussed in this manual may or may not be appropriate to your boat. Please check with your SPIRIT YACHTS dealer for any additional information needed.

SAFETY

THE PURPOSE OF SAFETY SYMBOLS IS TO ATTRACT YOUR ATTENTION TO POSSIBLE DANGERS. THE SYMBOLS, AND THE EXPLANATIONS WITH THEM, DESERVE YOUR CAREFUL ATTENTION AND UNDERSTANDING. SAFETY WARNINGS DO NOT BY THEMSELVES ELIMINATE ANY DANGER; THE INSTRUCTIONS OR WARNINGS THEY GIVE ARE NOT SUBSTITUTES FOR PROPER ACCIDENT PREVENTION MEASURES.

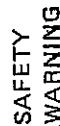

SAFETY WARNING Failure to obey a safety warning may result in injury to you or to others.



NOTE: Advises you of information or instructions vital to the operation or maintenance of your equipment.



TO THE BEGINNING SAILOR: This manual presumes that certain sailing basics will have been learned before taking out your SPIRIT YACHT for the first time. Sailing is a wonderful family recreation and an exciting sport. As with any boating activity, there are common hazards which must be learned through training and experience. Never attempt to learn to sail "on your own."

U.S. COAST GUARD & B.I.A. REQUIREMENTS

SPIRIT YACHTS HAS PROVIDED:

NAVIGATION LIGHT: Depending upon the model, factory-installed running light installations comply with United States Coast Guard (U.S.C.G.) regulations for either inland or for international lighting.

VENTILATION: Engine and fuel tank compartments comply with U.S.C.G. regulations and Boating Industry Associations (B.I.A.) requirements.

FUEL SYSTEM: Factory-installed fuel tanks and fuel piping comply with U.S.C.G. regulations and B.I.A. requirements.

BACKFIRE FLAME CONTROL: All inboards comply with U.S.C.G. regulations for carburetor flame arrestors.

ELECTRICAL SYSTEM: Electrical wiring and components comply with U.S.C.G. regulations and B.I.A. requirements.

B. S-28			
1. Head			34
2. Stove			38
3. Fuel			43
4. Ventilation			44
5. Steering			44
a. Tiller Steering			44
b. Pedestal Steering			45
6. Electrical			46
a. D.C. Master Switch			47
b. Standard Instrument Panel			49
c. Optional Electrical Switch Panel			51
d. Mast Lights			51
e. Cabin Lights			52
f. Shore Power			53
g. Mast Ground			53
7. Water			53
a. Standard			54
b. Pressure Water			55
c. Shower System			56
d. Hot Water System			57
e. Seacocks			57
8. Auxiliaries			57
a. OMC Saildrive			58
b. Yanmar 15 H.P. Diesel			60
9. Interior - Exterior			61
a. Double Berth - Main Cabin			61
b. Bilge Pump - Manual			61
c. Life Lines			61

Section IV: MAINTENANCE

A. Fiberglass Construction	62
B. Maintaining Hull Finish	63
C. Care of Sails	63

Section V: TRAILERING - 6.5/23

A. Choosing Your Trailer	65
B. Proper Mast Trailering	65
C. Trailer Balance	66
D. How to Rig and Maintain Your Trailer	66
E. Tips on Boat Launching	67
F. Storing Your Boat On A Trailer	68

Section VI: WARRANTY

Cautions Summarized	70
Glossary	74
Rules of the Road	76
	back cover

YOU MUST PROVIDE:

PERSONAL FLOTATION DEVICES: There must be at least one U.S.C.G. approved personal flotation device aboard for each person riding in the boat plus one throwable device.

FIRE EXTINGUISHER: Class A, Class I, and Class II Inboards must have a fire extinguisher on board.

BELL, WHISTLE or HORN: A sounding device is required by federal and state regulations on Class I (16' to less than 26' length) and Class II (26' to less than 40' length) boats.

REGISTRATION: You must properly register your boat and display the proper registration numbers as required by law.

STATE LAWS: The state in which you operate your boat may have other equipment requirements — check the law.

YOU SHOULD PROVIDE:

SAFETY KIT: Carry a safety kit that includes distress signals, flashlight, first aid kit, hand tools, anchor, tow line and paddle.



SPECIAL NOTE: A "Phillips" screwdriver is an especially important piece of equipment — it can be used to operate auxiliary engine controls (S-28 only) in the event the removable control handles are lost or misplaced.

BOAT SPECIFICATIONS

SPIRIT 6.5

LOA	21' 3" (6.5 m)
LWL	18' 9" (5.4 m)
Beam	7' 10" (2.4 m)
Displacement	2100 lbs. (952.5 kg)
Draft	1' 8" (0.5 m) Keel Up 5' 0" (1.5 m) Keel Down
Ballast	550 lbs. (249.5 kg)
Sail Plan	
I =	25.15' (7.67 m)
J =	8.82' (2.69 m)
P =	21.10' (6.43m)
E =	8.0' (2.44 m)
Sail Area (100% Foretriangle)	
Jib	110.9 Sq. Ft. (10.30 sq. m)
Main	84.41 Sq. Ft. (7.83 sq. m)
TOTAL	195.00 Sq. Ft. (18.12 sq. m)
Headroom	
Standard Cabin	4' 4" (1.32 m)
Pop-Top Cabin	6' 2" (1.88 m)

SPIRIT 23

LOA	23' (7.0 m)
LWL	20' (6.1 m)
Beam	7' 11" (2.4 m)
Displacement	2800 lbs. (1,270.0 kg)
Draft	2' Board Up (0.6 m) 5' Board Down (1.5 m)
Ballast	800 lbs. (362.9 kg)
Sail Plan	
I =	25.0' (2.32 m)
J =	8.67' (0.81 m)
P =	22.50' (2.09 m)
E =	9.5' (0.88 m)
Sail Area (100% Foretriangle)	
Jib	108.2 Sq. Ft. (10.05 sq. m)
Main	106.8 Sq. Ft. (9.92 sq. m)
TOTAL	215.0 Sq. Ft. (19.97 sq. m)
Headroom	
Standard Cabin	4' 9" (1.45 m)
Pop Top Cabin	6' 2" (1.88 m)

RIGGING CHECKLIST

SPIRIT 23K

LOA 23' (7.0 m)
 LWL 20' (6.1m)
 Beam 7' 11" (2.4 m)
 Displacement 3150 lbs. (1428.8 kg)
 Draft 3' 6" (1.0 m)
 Ballast 1150 lbs. lead. (521.6 kg)
 Sail Plan
 I = 27.0' (8.23 m)
 J = 8.67' (2.64 m)
 P = 24.50' (7.45 m)
 E = 9.5' (2.90 m)
 Sail Area (100% Foretriangle)
 Jib 117.0 Sq. Ft. (35.66 sq. m)
 Main 116.4 Sq. Ft. (35.48 sq. m)
 TOTAL 233.4 Sq. Ft. (71.14 sq. m)
 Headroom
 Standard Cabin 4' 9" (1.45 m)
 Pop-Top Cabin 6' 2" (1.88 m)

SPIRIT 28

LOA 28' 0" (8.54 m)
 LWL 23' 0" (7.01 m)
 Beam 10' 0" (3.05 m)
 Displacement 6900 lbs. (3068 kg)
 Draft 4' 9" Fin (1.42 m)
 3' 6" Shoal (1.07m)

Keel

Type

Cast Lead Alloy, External Bolted
2900 lbs. (1211 kg)

Weight

Sail Plan

I = 37' (3.44 m)
 J = 11.83' (3.60 m)
 P = 31.25' (9.52 m)
 E = 9.33' (2.84 m)

Sail Area

Jib 218.85 Sq. Ft. (20.21 sq. m)
 Main 145.78 Sq. Ft. (13.46 sq. m)
 TOTAL 364.63 Sq. Ft. (33.67 sq. m)
 LWL to Mast Top 40' 6" (12.3 m)
 Mast Height (1) 37.0' (11.2 m)
 Rudder Draft 3' 5" (1.05 m)

- Mast
- Boom
- Mainsail and Battens
- Working Jib
- Sail Bag
- Running Rigging
 - Main Halyard
 - Jib Halyard
 - Main Sheet
 - Jib Sheets (2 pieces)
 - Outhaul
 - Cunningham
- Standing Rigging
 - Upper Shrouds (2 pieces)
 - Lower Shrouds (2 pieces - 6.5 & 23 only) (4 pieces - 28 only)
 - Backstay (1 piece - 6.5 & 28)
 - Upper (1 piece - 23 & 23K)
 - Lower (2 piece - 23 & 23K)
 - Headstay
- Mainsheet System
 - Single Block with Becket (6.5 & 23 CB only)
 - Fiddle Block with Cam Cleat (6.5 & 23 CB only)
 - Mainsheet Traveler System (23K & 28 only) (23K - 1 Fiddle Block & 1 Boom Block) (28 - 3 Boom Blocks, 1 Triple Block)
- Winch Handle
- Shackles for Jib Tack
- S.S. Wire for Spreader Tips

SECTION I: OPERATION

CAPACITY

Spirit Yachts does not release any model until the boat has met the most stringent of engineering tests to comply with safety specifications for boat capacity, compartment ventilation, navigation lights, steering and fuel systems, as applicable.

NOTE: The auxiliary motor bracket available on some models is designed for up to 10 H.P. Do not use a larger motor.

A. BEFORE LAUNCH

1.  **CAUTION:** Make sure the hose is on all Seacocks or that the valves are closed.
2. Inspect the hull for cleanliness or damage. A dirty hull lessens performance, and increases drag. There is a possibility that the gelcoat finish can "blister" and peel if boats are kept in the water continuously. (See "Care and Maintenance", Section IV.)
3. Secure all accessories and loose equipment.

4.  Check that boat is properly equipped with U.S. Coast Guard required and approved safety equipment.
You must have a U.S.C.G. approved personal flotation device for each person on board. Small children and non-swimmers should be required to wear a life vest at all times. Check the condition of the flotation devices.

5. Have an approved fire extinguisher aboard.
6. Lighting: Check for proper operation.
7. If you have an auxiliary motor, make sure that it is securely fastened to the bracket.

B. RIGGING PROCEDURE — S - 23 & S - 6.5

(The S-28 rigging should be done by a qualified dealer or yard, as special equipment is necessary for stepping the mast. This should not be attempted by the owner.)

The first step in rigging your boat is to make a quick run through of the equipment to see that it is all there.

The checklist of the rigging for the boat is on page 7 of this manual. All the material required to sail the boat is included except tape or some other material to cover the spreader tips to prevent chafe.

Be sure to read Section IV, Part C for proper care of your sails.

SET UP

Uncoil rigging, leaving tags on each piece to avoid confusion. Begin attaching rigging to mast. (All turnbuckles connect to the chain plates at deck level.) The lower shrouds connect to the tangs just below the spreader sockets. The spreaders should be inserted in their sockets and bolted in. The upper shrouds are installed to their tangs on either side of the mast just below the top of the mast. The headstay and backstay are installed. The halyards should be installed at this point.

1. The main halyard is installed through the mast head, making sure the rope is fed through from the aft side of the mast forward. Run the halyard through halfway and tie to the cleat on the starboard side of the mast.

2. The Jib Halyard

- a. The S-23 jib halyard is run through the block just underneath the headstay tang. It is run through to the wire to rope splice, and tied off to the cleat on the port side of the mast.
- b. The S-6.5 jib halyard is run through the masthead, making sure the rope is fed through from the port forward side of the masthead. Run the halyard through to the wire to rope splice and tie off to the cleat on the port side of the mast.

RAISING THE MAST

1. Pop-Top Models (Stepped from the front or the stern as explained in the following section)

Position the mast on the cabin top with the bottom of the mast pointing aft. Loosen all turn buckles to fully extended

positions. Remove the pins from the plate at the butt of the mast. Attach the lower portions of the standing rigging, except the backstay, to their respective chain plates. When all the rigging has been set down and attached as prescribed above, check to see that none of the rigging is tangled or twisted. Move the mast forward so the forward hole in the mastplate is lined up with the forward hole in the plate above the mast-step. Insert the proper pin (note the two pins are of different diameters) in hole and lock with its cotter pin.

Raise the mast to its vertical position. Care must be exercised to insure that no twists develop in rigging causing a bent turnbuckle. Attach the backstay to the backstay tang. Now insert the pin in the mast step and lock with its cotter pin.

2. Standard Cabin or 1980 Pop Top Versions (Stepped from the rear)

Position the mast on the cabin top with the bottom of the mast pointing forward. Attach the lower portions of the standing rigging, except the headstay, to the chain plates. Loosen all turnbuckles to their fully extended positions. Remove the pins from the plate at the butt of the mast. All the rigging has been set out and attached as prescribed above, check to see that none of the rigging is tangled or twisted. Move the mast aft so the aft hole in the mast step plate is lined up with the aft hole in the plate or butt of the mast. Insert the proper pin (note the two are of different diameters) in the hole and lock with its cotter pin. Raise the mast to its vertical position. (Note that on standard cabin models or 1980 models the mast can be stepped from the aft.) Attach the headstay to the forward hole in the headstay tang. Now insert the forward pin in the mast step and lock with its cotter pin.

When this is complete, begin tuning your rigging for best sport and sailing performance. An explanation of tuning the mast follows later.

SWING KEEL/CENTER BOARD (S-6.5 & 23 Centerboard Only)

1. The S-6.5 is equipped with a 450 pound swing keel raised and lowered by a winch located at the front of the cockpit. After lowering the keel to its fullest extent, an L-shaped locking bolt located on the port side of the keel trunk should be tightened by hand. This can be reached through the forward

port access cover, (just aft of the port chainplate bulkhead), in the cabin. This keel friction bolt keeps the keel from bouncing in rough weather; however, it will still allow the keel to kick up should a submerged object be hit. The friction bolt should be unscrewed two turns before raising the keel.

WARNING: Do not screw the locking bolt in while the keel is in the up position, otherwise damage can be done when lowering the keel.

2. The S-23 Centerboard has a fiberglass ballasted board that pivots from the front of the keeltrunk. It is raised and lowered by the winch located on the port forward side of the cockpit. There is no centerboard locking bolt necessary on this boat and the centerboard can be raised and lowered as desired.

WARNING: Do not overtighten centerboard cable past full up position.

COMPLETION OF RIGGING

1. Installing the boom.

The forward end of the boom, or gooseneck, is bolted (S-23 and 23K) or snap-pinned (S-6.5 and 28) to the mast. The aft end of the boom is suspended from the snap on the backstay pennant.

For end of boom sheeting you will attach your fiddle block with cam cleat to the bridle provided on the transom. Then attach the single block with becket to the end of the boom with a boom bail and/or topping lift bar (depending on boat model) which are provided.

The mainsheet is dead-ended at the becket on the single block and lead down through the fiddle block. It continues back up to the single block on the boom and down once again to the fiddle block and out through the cam cleat. (A Figure 8 knot is advised to be tied on the loose end of this sheet.)

If your boat is equipped with the mainsheet traveler system, the double block is attached to the bale in the middle of the boom and the fiddle block with becket and cam cleat is attached to the traveler. The mainsheet is dead-ended on the becket of the fiddle block at the traveler. It then leads up through the double block and down through the fiddle block. It is once again run through the double block and out through the cam cleat on the fiddle block. (Figure 8 knot — See above.)

1. Boom/Reef Nomenclature
2. Eyestrapp Deadend Location

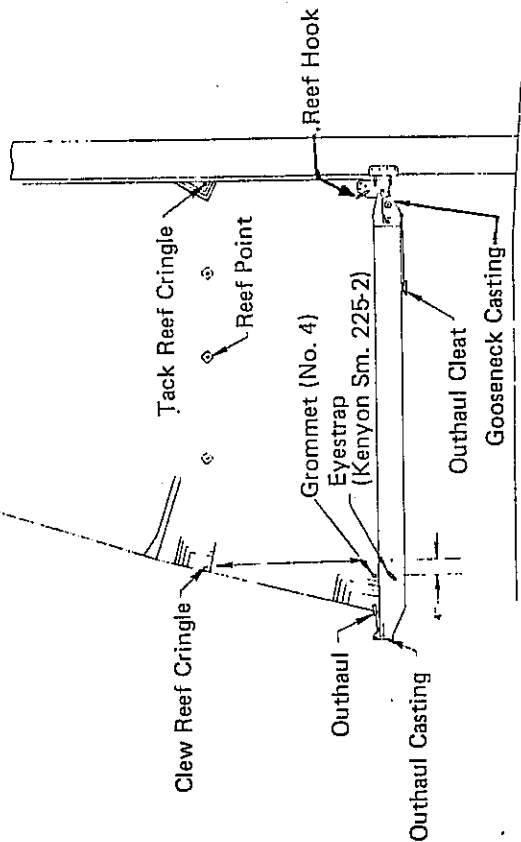

RIGGING THE REEF LINE FOR S - 28

1. Take reef line from outhaul casting, up through clew reef cringle and back down to the eyestrapp on boom (tie bowline in eyestrapp).
 - a. Alternative method -- take reef line from outhaul through clew reef cringle back down and around boom. Pass end line through grommet in foot tape of main and tie figure eight knot or timber hitch.
2. Use similar method to rig second reef line (use available second outside sheave in outhaul casting).
3. If you have a third reef point, rig an endless messenger between the second and third cringles with a short end loose as shown. After you've put in the second reef, untie the new unused first reefing line, tie it to the messenger and pull it through the third cringle and tie to the appropriate eyestrapp (or through the grommet in the foot of the sail if you prefer this method) and you are ready to set the third reef.

SEE DIAGRAM ON FOLLOWING PAGE

C. RIGGING PROCEDURE — S - 28

Our S-28 offers internal boom systems which internalize outhaul, jiffy reef lines and topping lift. The outhaul casting houses three sheaves and has a clevis pin attachment point for the topping lift. The gooseneck casting houses three internal exits for outhaul and reef lines.

The gooseneck consists of a rugged stainless steel universal block, a tack bracket with three position tack locations, and welded reefing hooks. This system offers a clean, simple and efficient method of boom controls. Since this system may differ from what you have been using, follow these instructions for efficient operation.

HOW TO SET UP BOOM FOR S - 28

1. A deadend for the reef line must be installed (unless 3550 boom is being used and then you can tie the reef line around the boom in proper location). This will vary in location depending on the cut of the sail and the reef location in the sail.
2. To determine the location of the deadend, lower the mainsail at the dock to the reef position. Place tack reef cringle on reef hook provided at gooseneck. Stretch sail tight by pulling on the clew reef cringle towards the outhaul. Mark position of clew reef cringle on boom when sail is tight. From this mark, measure 4" towards outhaul and mark on boom. At this point install an eyestrapp using two (2) 10-24 x 3/2" round head machine screws. An alternative deadend can also be a grommet installed by your sailmaker in the foot tape of the mainsail in the same location as described for the eyestrapp.
3. Use similar method to locate second reef deadend point.

SEE DIAGRAM ON FOLLOWING PAGE

Kenyon Internal Boom Systems

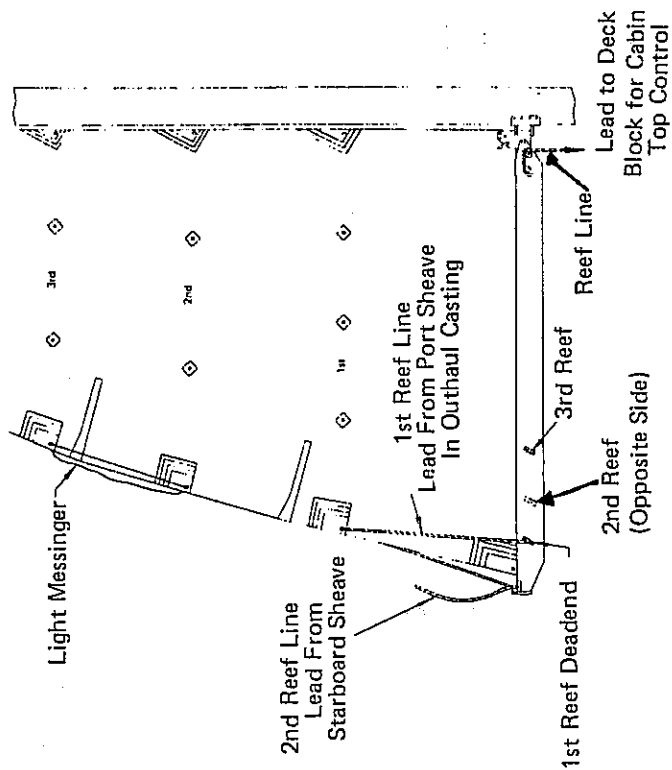

D. UNDERWAY (See Development of Boating Skills, Page 26)

1. Test steering for proper operation as you move slowly from dock.
2. Respect the rights of others. Be courteous.
3. Trim boat by weight distribution.
4. Helm "defensively" as you should drive your car.
5. Remember — the privilege to use public water carries with it an obligation to helm your boat in a safe and courteous manner.

E. TUNING THE MAST

Final and accurate tuning of your mast should be done during or after sailing. However, it will be necessary and possibly sufficient to rough tune your mast on your trailer or in the water before sailing.

The mast may be brought to the straight position across the boat by applying equal tension on each upper shroud and insuring that equal amounts of thread show on each of the upper shroud turnbuckles. The pressure on these shrouds should be firm, but not straining. A possible guide would be to tighten the turnbuckles all you can by hand and then a turn or two more with a pair of pliers and a screwdriver. The shroud should deflect about three inches when pushed six feet above the deck. Again, the shroud should be firm, but not too tight.

The lower shrouds should be set up in the same manner, checking along the mast track (back edge) and seeing that the mast remains straight.

The headstay and backstay are set up in the same manner except slightly more pressure than used for the upper shrouds. It is important to find a balance between having the headstay tight enough to keep the jib luff from falling off too much in a breeze, and excessive rigging load.

If the headstay and/or backstay are tightened for competition, we recommend loosening the rig after racing.

Final adjustment should be made while sailing in a 8-12 knot breeze. Observe bend in the mast, then tack and adjust the now loose shrouds to arrive at a straight mast when you tack back. Do not attempt to tighten the rigging on the windward or loaded side.

F. SETTING AND TRIMMING THE MAINSAIL

Your mainsail is designed to fit the special characteristics of your particular boat. Full consideration has been given to your boat's weight as well as mast and boom deflection, if any.

Your sail is designed so as to place the maximum draft (deepest portion) of the sail 40% to 50% aft of the luff (leading edge). The draft of your new main can be moved forward by **INCREASING** luff tension. Conversely, it will move aft if the luff is relaxed.

We have illustrated and cataloged the suggested luff tension for light, medium and heavy air.

Your main is equipped with a "Cunningham" grommet. This is placed nine to eighteen inches above the tack, and is used to adjust luff tension after setting the main halyard.

Suggested Luff Tension

Wind:	Tension:
0 - 10	Medium (Until wrinkles behind luff tape disappear)
Draft Placement:	40 - 45% aft.
10 - 15	Firm (Cunningham 1/3 down)
Maintain Draft:	40 - 45% aft.
15 - 20	Maximum (Cunningham 1/2 to full down)
Maintain Draft:	40 - 45% aft.

Foot or boom outhaul tension are adjusted to correspond to those of the luff, the harder the wind blows, the more tension should be applied. Try as closely as possible to match the foot tension to that of the luff. The actual mainsail hoisting procedure is as follows:

1. Hoist the main to the full up position on the mast.
2. Now set the luff tension, as described above to the wind velocity.
3. Tension the boom foot outhaul to match that of the luff.

IMPORTANT: Never tension the foot of the main sail before tensioning the luff. After sailing **RELEASE** the outhaul, give your sail a chance to relax. Remember, the luff is no longer under tension. Leaving the foot under tension causes unequal distortion.

Although much of all sail trim is done by "feel" rather than absolute, hard and fast rules, we have a few suggestions that we hope will get you started in the direction.

Trimming of the main is done with six basic controls:

1. Main Sheet
2. Main Sheet Traveler
3. Boom Vang
4. Cunningham
5. Jackline
6. Main Halyard

Your boat may or may not have as standard a main boom traveler, jackline, or boom vang. We suggest that you consider these options. Now on to trimming the main.

The most critical trim of your main occurs when going to windward. The place to look for proper trim is the leech (batten) area of your main. Overtrimming will show up in the leech area hooking to windward, i.e., causing excess drag and heeling movement because the air is trapped at the back of the sail causing the boat to heel. A loose or pumping leech indicates, conversely, that more trim is needed. The function described above is primarily that of the **MAIN SHEET**.

THE **MAIN SHEET TRAVELER**, available on the fixed keel models S-23K and S-28, has the primary function of controlling the point of trim, inboard or outboard, at which the mainsheet trim block attaches to the boat. The **MAIN BOOM TRAVELER** should be used as follows:

- Wind:
- 0 - 5 Set the main boom slightly to windward of the boat's centerline.
 - 5 - 10 Set the main boom at the boat's centerline.
 - 10 - 15 Set the Traveler to the full outboard position. This reduces heeling and allows the air to escape more freely from the leech area of the mainsail.
 - 15 - 25 Set the Traveler 1/2 the distance between the centerline and the leeward aft corner of the boat.

The Boom Vang is used primarily when the mainsheet is eased and the end of the boom is no longer in a position where the Main Sheet Traveler is effective, (the end of the boom now being far out over the rail).

The Boom Vang which is attached to the base of the mast then up to the center of the boom by means of pulley arrangement provides mechanical advantage, then basically assumes the function of the Main Boom Traveler.

As the main boom is eased, the boom rises causing the upper part of the main to twist off to leeward rendering the top 1/3 or the main ineffective. The Boom Vang then hauls the boom down (not in) causing a uniform leech curve while making the upper leech once again, effective.

Tell tales located about 25% aft of the chord length along the luff of the main can also be most helpful. We suggest 3/8 inch streams about 7 inches long of lightweight nylon taped to each side of the sail. On the average boat, three sets, about six feet above one another, should be ample. When going to windward with the main trimmed as previously described, if you are sailing too close to the wind, the ~~windward~~ tell tale will flow aft again.

Conversely, sailing too far off the wind will cause the leeward tell tale to flutter. Bring the boat up a bit and it will then flow aft.

If you master the above mainsail setting and trimming technique you will be well on your way toward the most effective use of your new main.

G. REEFING PROCEDURE

1. Ease boom vang and mainsheet — make sure topping lift is secured in position.
2. Lower main halyard so that tack reef cringle can be placed on goose-neck reef hook. Retension main halyard when hooked in place.
3. Clew reef line must now be tensioned so that clew reef cringle is brought down snugly against boom.
4. Readjust mainsheet and boom vang.
5. Use similar method for second reef.
6. The reefed folds of cloth can be rolled up and secured with short lines through the reef points and around the folds and boom. Be sure to untie these first when preparing to shake out the reef.
7. UNREEFING — just reverse this process to unreef mainsail.

H. SETTING & TRIMMING GENOAS & JIBS

The procedure for setting the Genoa is quite similar to that of the main. Your Genoa is designed so as to place the maximum draft (deepest portion) of your Genoa — 35% to 50% — aft of the luff (leading edge).

Because your Genoa is of the "stretchy" luff (no rigid wire) concept, the draft is very easily moved forward through the use of luff tension. Conversely, it moves aft when the tension is eased.

A suggested procedure for having the proper sail set at all times would be to set your Genoa up on a stay when the wind is 8 - 10 m.p.h. Set the halyard tension so as to remove the HORIZONTAL wrinkles immediately behind the luff tape. Now look at your sail from the Windward bow sighting aft, the draft (deepest portion) should be 50% of the chord line (horizontal distance from leading to trailing edge of sail). This, then, would be your light to medium luff tension position. Mark your halyard position with tape or magic marker.

Now increase the luff tension until a Vertical tension wrinkle develops immediately behind the luff tape. Ease off slightly until the wrinkle disappears. Look at your Genoa. The draft is now 35% aft. Mark your halyard. This, then, is the heavy air setting.

As you become more familiar with this procedure you will soon be able to "eyeball" the draft and be well on your way to obtaining optimum Genoa performance.

Trimming the Genoa

There are two basic considerations in Genoa trim. One, the movement of the jib leads fore and aft; two, the movement of the trim point in or out in relationship to the boat's centerline. (Many cruising boats do not have inboard or outboard adjustments as is more prevalent on the smaller one-design sailboats.)

First and foremost, the system for setting your jib lead position properly fore and aft is relatively easy.

Bring your boat on the wind. Trim your Genoa sheet in. Now bring your boat up into the wind very slowly. If the luff breaks first at the upper portion of the Genoa, the leads are too far aft. If the luff breaks first in the lower portion of the sail, the lead is too far forward. When your lead is properly located, the Genoa will break evenly along the entire length of the luff.

If the athwartship (in and outboard) position of the jib leads are adjustable we suggest light air settings of 9 to 11 degrees, heavy air setting of 11 degrees plus.

This in and outboard movement of the jib leads has one objective, and that is to accelerate the smooth flow of air aft over the leeward side of the main. The effect thereby created is known as the "slot effect". The lighter the wind, the more closed the slot should be made, causing a Venturi (squeezing) effect and accompanying acceleration of air aft. Conversely, as the wind increases, the slot is opened, reducing the velocity and minimizing the tendency of backwinding (deflecting air) into the main.

Use of the "foot cord" is basically an "eyeball" function. The foot cord on your Genoa is readily adjustable by means of a mini "V" jamcleat affixed to the tack of the Genoa. The simple rule to follow in setting foot cord tension is to increase tension until the lower foot "stands up" in uniformity with the remainder of the Genoa.

As a general rule you will need more tension going upwind, easing off as you bear off the wind. It is normal to see a slight cupping or "end plate" effect in the lower two to four inches of the foot.

The use of tell tales on the Genoa luff are most helpful. These tell tales should be located at about one-third of the luff length intervals vertically and about 25% of the distance aft between the luff and leech.

The tell tales should be placed as a set, one each on the windward and leeward sides of the sail. If you are sailing too high, the weather tell tale will flutter; too low and the leeward tell tale will flutter. Transparent circular tell tale windows may be installed for better tell tale visibility.

The working jib trim and sail set suggestions are identical to those of the Genoa. Foot cords, however, are not necessary in working jibs.

I. SETTING AND TRIMMING THE SPINNAKER

In order to properly analyze maximum spinnaker efficiency, we have broken the use of the chute into five categories:

Light Air Runs

On light air runs we suggest making the shape of your chute as full as possible. This is accomplished by lowering your spinnaker pole to the lowest position possible on the adjustable pole track. Ease the pole lift to allow the pole to set perpendicular to the mast. Lead your sheets farther forward. This will tend to put more tension on the leech of your spinnaker, taking the strain off the chute itself, which in turn makes the chute fuller and allows it more freedom to float in the lighter air. Light spinnaker sheets will also be of help. When at all possible strive to keep the tack and crew of the spinnaker flying at the same height. If the clew drops lower than the tack, lower the pole to compensate. If possible, when sailing dead downwind, heel your boat slightly to windward. This allows the chute to float out from behind the main making it considerably more efficient.

Light Air Reaching

The inboard pole end should now be in the middle position on your spinnaker pole track. Again, keep the clew and tack at equal height. The spinnaker pole should be at a precise perpendicular angle to the mast. Now ease the halyard slightly. This will ease the leech and flatten the spinnaker slightly, giving better efficiency particularly when the wind is slightly forward of abeam.

A 10 degree angle of leeward heel will further aid in keeping your spinnaker full.

Heavy Air Running

You will find little, if any, problems keeping the spinnaker drawing effectively downwind in moderate or heavy air. Keep your crew weight aft. This keeps the rudder functioning effectively. Do not allow your spinnaker to oscillate. This may be accomplished by moving your spinnaker sheet lead forward and/or easing the pole forward and simultaneously trimming the sheet.

In heavy following seas it may be impossible to eliminate oscillation, but the above procedure will help keep it under control.

Heavy Air Reaching

The secret to a power reach is to keep your boat on her feet. Keep the heeling angle at a minimum. Keep the crew weight aft for maximum rudder control and, above all, anticipate the puffs before they are on you. Concentrate on the wind 10 boat lengths abeam and astern of you. When you see a blast of wind off your stern quarter, do not wait until it hits you, causing you to heel, round up and lose control. Bear off before it reaches you. If it looks as though it may last more than a minute, guy the pole aft and ride it downwind. Keep your boat moving, maintain control and as the blast eases, let the pole forward and bring your boat back to its original heading. Remember, "Anticipate the puff before it reaches you."

Spinnaker work requires practice and the coordination of the helmsman and crew. It also provides some of sailing's most thrilling moments.

General Spinnaker Trimming

Almost constant attention is required if maximum efficiency is to be realized from your spinnaker. The luff must be under constant scrutiny and the sail trimmed on the verge of a break or curl.

Remember, whenever raising or lowering the spinnaker pole to adjust for varying wind conditions, as described above, the pole must be perpendicular (90 degrees horizontally to the mast). Do not allow the pole to hike up or sag down.

In order to accomplish this, the pole lift and inboard spinnaker pole track setting must be raised and lowered simultaneously.

It is also of paramount importance to keep the clew and tack of the spinnaker flying at equal heights. This assures that your spinnaker is not being distorted and that the designed shape is being maintained.

J. REEFING THE GENOA

Many people confuse roller furling as a means of reefing. True, some reduction in sail area may be effected through the use of roller furling gear but generally a Genoa will not trim properly when a substantial amount of sail is furled.

Genoa reefing is a means of reducing sail area and at the same time providing proper sheeting angle for an efficient sail shape. Basically the principle for Genoa reefing is the same as Jiffy Reefing on the mainsail. A set of reef points including a secondary tack and clew cringle is installed in the Genoa. As the wind increases the halyard is eased and the reef tack is lowered to the reef position. The sheet is then attached to the reef clew fitting. The excess sail area at the foot is then furled and tied.

Two important considerations on the furling Genoa are: one, the Genoa must be somewhat heavier, (one ounce) than the standard Genoa, because it will be used in heavier wind ranges when reefed; two, a reefing Genoa will reduce your headsail area by a maximum of 20%, i.e., 150% Genoa reduces to 130%. So, when you plan to install reefing in your Genoa keep in mind you will need heavier sail cloth and that the maximum reduction of area will be 20%.

How To Install a Jiffy Genoa Reef

1. Install a pad eye on the deck (port side) as close as possible to your regular jib tack fitting.
2. Attach a line to the pad eye and pass it through the Genoa tack reef cringle. (Make sure this line is twice the height of the reef plus 3 ft.)
3. Install a block (starboard side) as close as possible to the regular jib tack fitting.
4. Lead the reefing line previously passed through the reef down and aft through the block.
5. Install a small cleat about one foot aft of the block. This cleat then becomes the point at which the tack reef line is secured.

The above gear will allow the quick reef to be taken while fully under way. If an extra jib sheet is available, it is possible to "pre-sheet" the jib, making the jib reefing a simple instant procedure.

K. POP TOP OPERATING INSTRUCTIONS — S - 6.5 & 23

The pop top on your Spirit Yacht was designed to provide a maximum of room, ventilation and ease of operation. Proper care taken in maintenance and operation of your pop top will provide a low service feature to your boat in the years to come.

Please follow the instructions listed below for correct operation:

ASSEMBLY OF PARTS:

(The mast slide mechanism consists of a tube with attachment ear, a small slide stop and fasteners.)

Assembly:

1. Unscrew the mast stop from bottom end of mast. First, slide in the $\frac{3}{4}$ " diameter tube with the "ear end" down (towards mast step) Second, slide in the small black "slide stop." These should be loose in mast.

NOTE: If your mast has the bail for a boom vang, this needs to be removed. A special yoke is available for installing a boom vang.

2. Re-install mast step.
3. Caution should be used when stepping the mast. The forward bracket (external) on the pop top itself, and the mast slide can be bent if considerable care is not taken when stepping the mast. It may be necessary to unlatch the pop top and move it aft approximately 2" before stepping the mast. The mast should be stepped from the bow (Pre 1980 Models). 1980 models have a two piece pop top bracket which bolts to the top itself. With this system, stepping the mast from the stern is possible.
4. After the mast is stepped, bolt the mast slide to the forward bracket on the top.

CAUTION: Do NOT attempt to unstep mast while the pop top is still bolted to the mast.

TO RAISE:

1. After entering the cabin, unscrew the hold down dog latches on the port and starboard to release the top.

2. With the main hatch slide forward, (always) raise the aft end of the top, taking care that the hold down latches are free. The support bar should slide forward and be locked into position by screwing the thumbscrew into the hold in the track. (If the support bar is stiff, add a little grease to the track.)

3. Then raise the front of the pop top (it will follow the mast line, until it is level.)

4. Slide the "slide stop" up the mast track until it reaches the mast slide hardware on the top. Then tighten.

 **CAUTION:** The top is not designed to support the full weight of a person. **DO NOT SIT ON THE POP TOP.**

TO CLOSE:

1. Reverse procedure.

 **CAUTION:**

1. Do not allow fingers or hands near the contact edges between top and deck when raising or lowering the top.

2. Always attach safety hook to mast when the top is in open position (Pre 1979 Models).

3. Always have a firm grip on top when opening or closing. The pop top has considerable weight, and therefore care must be taken when raising or lowering it.

4. Do not lift top by the main sliding hatch. The main hatch was not designed to lift the top.

5. Always close the top during high winds or rough conditions.

6. Use extreme care when sailing with pop top in up position.

L. KICK-UP RUDDER OPERATING INSTRUCTIONS

Install Rudder In Normal Fashion

To prevent rudder from riding up, be sure 2" cotter pin is installed to lock rudder on pintels (6.5)/gudgeon pin (23).

OPERATION IN SHOAL WATERS

1. Loosen friction locking handle.
2. Release rope from all clam cleats.
3. Pull up on portion of rope leading from trailing edge of rudder blade.

4. When desired angle is achieved, rudder blade may be either cleated in clam cleat for positive, non-release attachment or friction lock may be set by adjusting handle on side of aluminum plate. When angle of lower blade is set by friction lock, it will swing up upon striking underwater objects.

 **CAUTION:** Avoid sudden quick movement of tiller when rudder is in up position as damage to rudder head or blade may result.

5. Return rudder to normal full down position when sailing in non-shoal waters.

 **CAUTION:** Sailing in shoal waters with rope cleated by clam cleat will result in damage to rudder upon striking submerged, solid objects.

NORMAL POSITION, KICK-UP MODE

1. To set rudder to kick-up upon striking-submerged objects, snug friction locking handle and release rope from all clam cleats. Upon striking submerged object, lower blade will swing up within friction lock mechanism.

2. To return rudder to normal position, release locking mechanism, release retrieve rope from clam cleats, pull up on portion of rope attached to leading edge of rudder, reset locking handle and release rope from clam cleats.

SECTION II: BOATING SKILLS

Development of boating skill will depend on practice, study, and observation. The skillful boat operator will learn to sense when, in the interest of safety, a change of speed or course is necessary. He will gradually gain an instinctive touch in protecting his boat from strain, stress, and avoiding possible hazardous situations.

Until you are capable of knowledgeable weather forecasting, get in the habit of checking your local newspaper, radio and TV broadcasts, consulting operators of local marinas or placing a call to the nearest Coast Guard Station or airfield to get up-to-date information on marine weather forecasts.

Small Craft Warnings

If small craft warnings are broadcast for the boating area, or if storm warning signals are displayed, don't go boating just because the sky seems clear. Learn to respect the weather and its consequences.

Water Surfaces Give Clues to Depth

Make it a practice to study the water ahead. Deeper water is usually darker in color and shallow water is lighter.

Ripples will build up more easily in a light breeze on water flowing over shallows than it will in deep water. Usually, disturbed water marks the location of underwater obstacles.

In navigable rivers, deeper water will be found on the outside of bends. At curved sections, mud and sand bars are more likely to build up on the inside curves.

A. BASIC RULES

Knowing the "Rules of the Road" (see back cover) is a legal requirement of all boatmen. "Rules" are a combination of common sense principles blended with courtesy. Courtesy involves a recognition of the other fellow's rights, comfort and safety.

Speed limit signs are usually found at or near boat anchorage or swimming areas.

You are expected to keep clear of boatmen engaged in fishing or swimming.

Avoiding persons engaged in water skiing or scuba diving is of prime importance.

The privilege to use public waters carries with it an obligation to operate your boat in a safe and courteous manner.

A cardinal principle of boating requires that you be ready at all times to render assistance to other craft in need of aid.

If your passengers decide to swim, take a personal inventory from time to time. Use the "buddy system" with passengers paired off, each responsible for the other. Don't let swimmers stray too far.

 **CAUTION!** Swim only in known waters, when the boat is securely anchored. Keep one person, who understands the operation of the boat, on board at all times.

It is good practice to tell some responsible persons where you are going and when you expect to return (both night and day).

U.S. Coast Guard Publications

You are invited to write to the U.S. Coast Guard for information relative to boating safety. It is suggested that you indicate your particular interest in:

- Taking a safe boating/seamanship course
- Applying for home study "Skipper's Course"
- Information on Federal equipment requirements
- General safe boating literature

Address your inquiry to the Coast Guard Office nearest you.

B. CHARTS

When the boatman leaves areas marked with bouys and cruises into unfamiliar areas, a chart is a necessity. A chart is a mariner's road map. It can help you reach a destination without jeopardizing your boat and passengers.

Most marine supply stores carry a full complement of the government charts, tables, light lists, and piloting guides needed to navigate local waters. If you find that the store is out of stock, however, or if you require charts or other publications for distant areas, you can obtain the necessary materials by writing directly to the appropriate issuing office, as listed:

1. Nation Ocean Survey, Distribution Division, C44, 6501 Lafayette Avenue, Riverdale, Maryland 20840. Telephone (301) 436-6990. Publishes charts for all U.S. coastal areas, the Great Lakes, sections of major rivers, Coast Pilots, tide tables, tidal current tables, tidal current charts, Chart No. 1, Catalogues of NOS charts. Distributes Notice of Mariners
2. Defense Mapping Agency Depot, 5801 Tabot Avenue, Philadelphia, Pennsylvania 19120. Telephone: (215) 697-4262. Issues charts of foreign waters, a chart catalogue and Notice to Mariners. Distributes Chart No. 1.
3. U.S. Army Corps of Engineers. The district office in each state issues charts and chart lists for inland lakes and waterways.
4. Lake Survey Center, 630 Federal Building, Detroit, Michigan 48226. Publishes charts of the Great Lakes and connecting rivers, Lake Champlain, and New York State Canals, and a chart catalogue.
5. Superintendent of Documents, Government Printing Office, Washington, D.C. 20402. Distributes light lists.
6. Hydrographic Chart Distribution, Canadian Hydrographic Service, Surveys, and Mapping Building, 615 Booth Street, Ottawa, Ontario, Canada. Distributes Canadian charts and marine publications.

C. ACCESSORY EQUIPMENT REQUIRED

No boat should be operated without a complete inventory of accessory equipment. The U.S. Coast Guard requires that each boat, depending upon size, carry certain approved safety accessories. Other law enforcement agencies — state, county, or municipal — impose similar equipment requirements that do not fall under Coast Guard jurisdiction.

Personal Flotation Device

All boats must be equipped with a U.S.C.G. approved personal flotation device for each person on board the boat. Buoyant vests are most highly recommended.

 **CAUTION:** Small children and non-swimmers should be required to wear them at all times. All persons aboard should have a flotation device readily available when there is a threat of a storm or when navigating on dangerously rough water.

NOTE: All personal flotation devices must be tagged or marked with a U.S. Coast Guard approval number.

Navigation Lights

Depending on the model, Spirit Yachts come equipped with navigation lights to conform to either international or inland lighting rules as required by the Coast Guard.

Under inland rules a boat is required to show a combination red and green light forward when underway from sunset to sunrise. This combination light must be visible from a distance of one mile. A white light visible through twelve (12) points for one mile must be displayed aft.

A white light visible 360 degrees for two miles must be displayed when anchored or rowing at night.

NOTE: The above regulations are duplicated by many state boating laws specifying required equipment for state and local waters not under federal jurisdiction.

Some local laws require additional equipment. It is important that you obtain a copy of local laws.

D. RECOMMENDED ADDITIONAL GEAR

Important both to safety and convenience are the following items:

- | | |
|---------------------------------|-------------------------|
| Basic Gear | |
| Suitable anchor and anchor line | Flares |
| Tow line | Bilge pump and bailer |
| 2 lightweight fenders | Oar or paddle |
| 2 mooring lines | Boat Hook |
| Flashlight | Navigation Gear: |
| Spare fuses | Compass |
| First Aid Kit | Parallel rulers |
| Sunburn lotion | Dividers |
| Portable searchlight | Charts of the area |

Basic Tools

- | | |
|---------------|--------------------------------------|
| Pliers | Screw driver — "Phillips" and "Slot" |
| Riggers Knife | Adjustable wrench |
| Hammer | Roll of soft wire (SS Preferable) |
| Fuses | Electrician's tape |

Extended Cruising

Auxiliary motor
Spare light bulbs
Spark plugs for auxiliary

Fuses, Spare battery
Extra sheets
Spare pull cord for auxiliary

Check with your dealer and other experienced sailors for advice on additional equipment.

NOTE: If you carry fuel for an auxiliary motor, you should carry a fire extinguisher. However, due to the danger of toxic fumes, vaporizing liquid extinguishers are not recommended. Dry chemical, carbon dioxide, or foam extinguishers are best.

E. WHAT SAIL TO ADD FIRST

In all probability your boat is standard equipped with a main and working jib or lapper. We have listed below in order of importance the additional sails you might consider:

1. No. 1 Genoa (150% - 170%) *
2. $\frac{3}{4}$ Oz. All Purpose Spinnaker *
3. No. 2 Genoa (130% - 150%) *
4. Drifter Reacher (150% - 170%) *
5. Close Reaching Spinnaker
6. Heavy Genoa (150%)
7. Spinnaker Staysail - Big Boy
8. .05 Oz. Spinnaker
9. Storm Jib
10. Genoa Staysail
11. No. 3 Genoa (110% - 120%) *

Sails 1, 4 and 9 are suggested for cruising or occasional racing.

* We suggest as a general rule, 150% Genoa's; however, for boats racing under the M.O.R.C. rule and boats of older design (5 years or more) with similar "J" measurements, a 170% may be preferable.

F. WHAT ABOUT CLOTH WEIGHT

The cloth weight for a given sail is predetermined by the sail type, i.e., the Genoa, main, etc., total sail area, size of boat and last, but not least, the wind range the sail will most frequently be used in.

Cloth weight, in itself, is only half the factor in determining that your new sail will perform as designed.

Through the use of the Scott Tensile Tester we have arrived at what we consider the best stretch ratio for a given sail. Keep in mind that stretch ratios differ greatly within identical cloth weights, i.e., a high aspect ratio mainsail (3 x 1) requires greater stability along the leech area of the sail. Whereas a 150 Genoa requires an entirely different stretch ratio of 1 x 1 because the trim angle (strain) on the Genoa is evenly distributed and the sail itself is virtually an equilateral triangle.

With the above in mind we believe you will understand when we say "Cloth weight alone doth not a good sail make."

Last, but not least, is the consideration of cloth finish. Only the finest leading suppliers of sail cloth are considered in the manufacture of these sails. We demand a tightly woven, high count cloth. We, however, have the availability of using soft, medium, or firm finished sail cloth.

We have listed below the suggested use for each finish:

Soft Finish: Large sails or on a cruising boat where stowage and ease of handling are a consideration.

Medium: For the cruiser-racer, really, the best of both worlds. Takes up more space and is slightly harder to handle, but has a better shape retention than the softer finish.

Firm: "Bullet proof" should only be considered on smaller design racing machines where stowage and deck handling are not a consideration.

G. TYING A BOWLINE

The bowline is the seaman's most reliable and useful knot. A quick, strong method of making an eye in a line, the bowline never slips or jams. It can be tied in the end of a line or in the middle, with one loop or two, depending on the situation. In fact, if a sailor were able to learn only four knots in his life, this should be one of them. (The others are the square, the half hitch and the figure eight.) The bowline if the knot used with your jib sheet.

Here is the simplest and most reliable method for tying the basic bowline in a line's end.

1. Form an overhand loop, holding the junction firmly between the thumb and fingers of your right hand.

SECTION III: SYSTEMS

A. S-6.5, S-23CB & S-23K

1. WATER

Water is stored in a water tank (approximately 5 gallons) contained in the galley. This tank is filled through the access cover found on top of the galley directly into the tank.

Drainage on the S-6.5 is into a 2.5 gallon jerry jug located under the cockpit floor. This jug needs to be emptied periodically. On the S-23, the water exits through a bronze gate valve located in the port cockpit locker. This gate valve should be closed when the galley is not in use.

2. ELECTRICAL

Spirit Yachts are wired for 12 volts direct current, and all wiring is color-coded as indicated on this wiring schematic for the 6.5 and 23.

Note that your boat's standard harness is protected by a master fuse. This is a 10 or 15 amp fuse and replacement should be made only with a fuse of the same rating. If accessory electrical equipment is installed, each item should be separately fused with proper size fuse and not more than 5 amps of combined electrical load should be attached to the boat's installed wiring harness. If additional current capacity is required, a separately fused circuit of proper sized wire should be added from battery to device.

The mast light wiring attaches to the boat wiring through a plug located just forward of the mast step. **CAUTION:** This plug is to be disconnected before unstepping the mast.

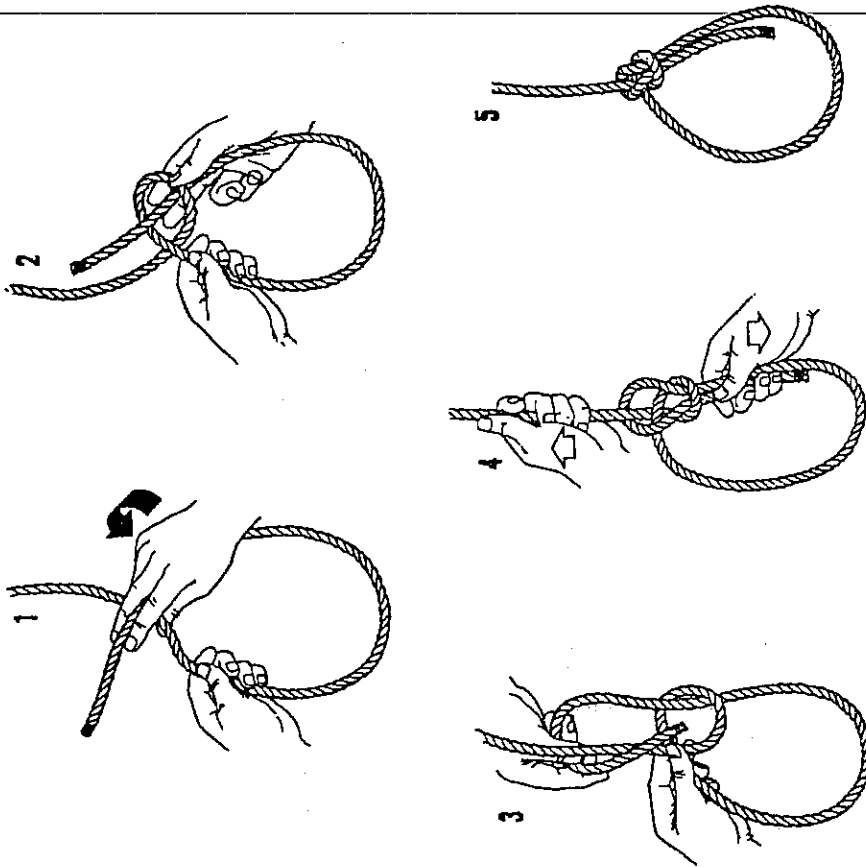
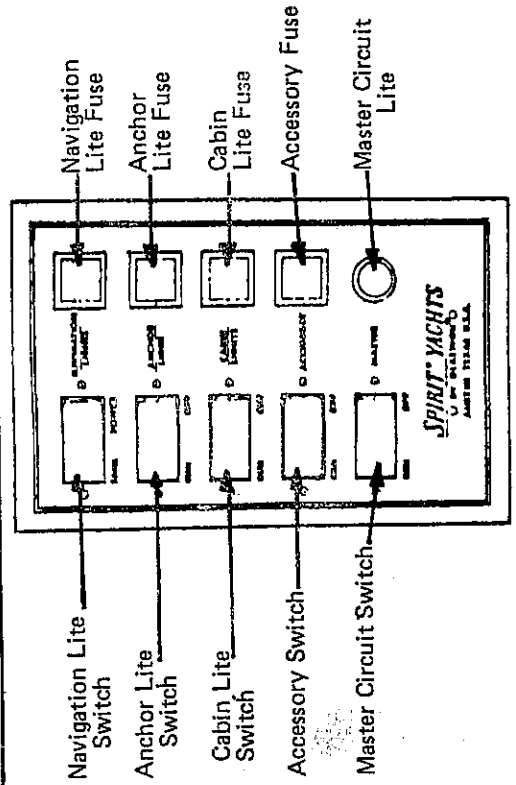

- Turn your right hand over, palm up, to form a smaller loop with the working end sticking up through it.
- Hold the loop in your left hand and use the right hand to lead the working end around behind the standing part, then forward and down through the small loop.
- The working end should finish inside the big loop, parallel to the right side. Pull down the working end and the right side of the big loop with one hand, and pull the standing part with the other to draw up the knot.

5. The finished knot will look like figure 5.

3. FOLDING BERTH

This option fills the area between the port and starboard settee. It is supported by grooves molded into the hull liner in the S-6.5 and four (4) teak cleats fastened to the hull liner on the S-23CB and S-23K. The center section is supported by two (2) legs.

 **WARNING:** Make sure that both legs of the folding berth are down and snapped in place before using.

4. WINCHES

On the S-6.5, the 450 pound keel is raised and lowered by a self-braking winch. To raise the keel the winch is cranked in a clockwise direction. To lower the keel the winch is cranked in a counter clockwise direction just enough to disengage the clutch and let the keel weight unwind the winch reel.

On the S-23CB the center board is raised and lowered by a ratchet winch. To raise the center board, the winch is cranked in a clockwise direction. To lower the center board, flip the lever (located under the cockpit lid on the winch) aft and crank the winch in a counter clockwise direction.

 **CAUTION:** On either of the above models damage can occur if the keel or center board respectively is raised too far, or if it is raised or lowered out of water.

B. S - 28

1. HEAD

As standard, a portable head has been installed for use in those areas that permit it (it is not legal in all waters for a yacht of this size — check your local regulations). This unit has, approximately, a 5 gallon holding tank capacity which should provide in the range of fifty (50) uses. It is a two part head with the fresh water tank on top and the holding tank below.

 **CAUTION:** Always install the correct amount of chemical treatment to any holding tank before use. Both parts of the head fit together and are snapped as a unit to the fiberglass shower pan within the water closet.

An optional china bowl, marine head provides additional capacity with a thirteen (13) gallon holding tank. Complete operating instructions follow:

GENERAL INSTRUCTIONS

An instruction plate is always furnished with each Seaclo. Be sure to place it where it will be seen and read! Your landlubber guests will appreciate proper instructions on the use of your toilet when they first come on board. You will save yourself considerable trouble if, at the time, you emphasize that rags, bobby pins, paper towels, etc., should not be discarded in the toilet.

When a Seaclo is first placed in use, it may be necessary to put a pail of water into the bowl to prime the pump. This will not be required after the Seaclo has once been used.

Where the toilet is set considerably below the waterline, the W-C Vented Loop, Fig. 1548, should be installed in the discharge line, as shown in line drawing above. The bronze "U" loop has an integral air vent which works automatically to prevent back syphoning into toilet, yet seals tightly so there is no possibility of leakage. (Not on S-28)

The flush water supply valve is opened by raising the lever on the side of the cylinder.

Before using the toilet, open the supply valve and pump some water into the bowl. After use, keep the supply valve open and pump slowly.

Once the bowl is clean, pump five or six extra strokes to thoroughly clear the discharge line of all refuse. Then close the supply valve and pump until the bowl is empty. When running in rough seas, or leaving the boat overnight, it is advisable to pump the bowl dry to prevent splashing. When the boat is unattended, it is advisable to close both sea cocks.

NORMAL CARE AND MAINTENANCE

If your Seaclo works hard, check to make sure the sea cocks are wide open and that no kinks appear in the lines. Sometimes the sea cocks work shut with consequent restriction in the intake or discharge lines.

SEE DIAGRAM "A" ON FOLLOWING PAGE

Some oil or grease on the piston rod and bearing pins in pump handle assembly makes for easier pumping. To reduce wear and maintain easy pumping operation, do not tighten the piston rod packing nut any more than necessary to prevent leakage around the rod. A little waterproof grease applied once a season to the packing found under this nut will do the trick.

DIAGRAM "A"

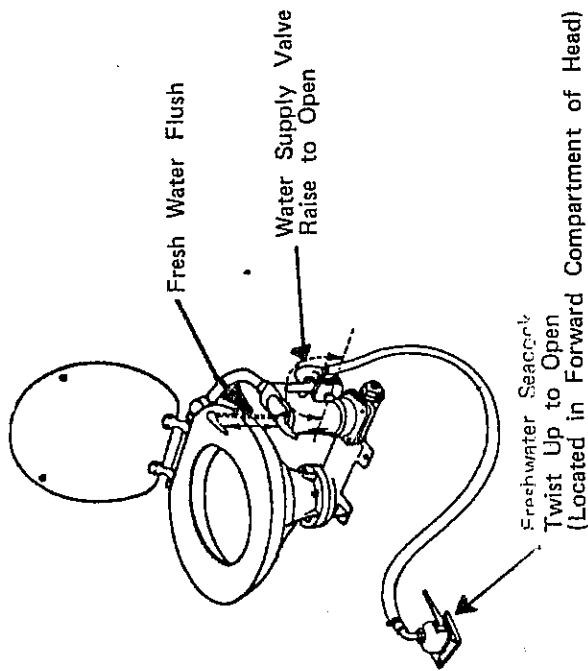

If a foreign object becomes lodged in the toilet, remove the screws which hold the tail piece to which discharge pipe is attached and check the "Joker" valve. This is the spot where matches, bobby pins, or similar items are likely to catch and cause trouble.

If pumping action becomes stiff and the above checks have been made, "Sea-Lube", a special water soluble lubricant, should be used. A few cups of "Sea-Lube" put into a dry bowl and pumped out of the bowl into the cylinder, but not overboard, will keep the unit working freely. A stroke or two is enough. Try to allow the "Sea-Lube" to stand for 24 hours.

HAUL-OUT

When you haul out for storage, certain steps should be taken to keep your Seaclo in first-class condition.

Fresh water should be allowed to stand in the pump for several days to dissolve the accumulation of salt in the cylinder and hose lines. Repeat this process, then pump dry. Remove drain plug in waste arm to drain any water which might remain. Replace drain plug and pour a few cupfuls of "Sea-Lube" into the bowl and pump the "Sea-Lube" out of the bowl into the bottom of the cylinder. A stroke or two is enough.

Allow "Sea-Lube" to stand for 24 hours - pump dry and remove drain plug.

DO NOT PUT OIL, KEROSENE, GASOLINE, OR ALCOHOL IN THE BOWL OR PUMP. THEY WILL RUIN THE VALVES.

If anti-freeze is used, it must be a glycol base.

COMMISSIONING INSTRUCTIONS

Replace drain plug in waste arm and use "Sea-Lube" as outlined in Haul-Out Instructions. Allow "Sea-Lube" to stand for 24 hours. If Haul-Out Instructions were followed, your Seaclo should be ready for use. In the event your Seaclo is worn or has not had proper care, it is recommended that the pump unit be disassembled, the required new parts installed and the units reassembled, with waterproof grease being applied to the piston leathers and cylinder wall. This greasing should be done whenever disassembly is required.

Be sure to check the "Joker" valve. If stiff, it should be replaced.

Proper care will assure you of a long-lasting, free-working unit.

After boat is overboard, it is good practice to make periodic checks on the waterlines, etc., to make certain that all connections are tight and that valves are functioning properly.

REPAIR PARTS

After considerable use, your Seaclo may require some repair parts. A handy W-C Repair Kit is available, containing all of the items you will probably need. Call for it by name. Be sure to use only W-C repair parts made for your model of toilet.

OPERATION — ELECTRIC HEAD

When the "Electra-Head-Mate" is ready for first-time use, press "FILL" button to prime pump. Then, pump water into bowl until it is about $\frac{3}{4}$ full, then press "EMPTY" button to discharge. Finally, check carefully for leaks in plumbing installation, and the unit is all set for duty!

HAUL-OUT

When you haul out for storage, certain steps should be taken to keep the "Electra-Head-Mate" in first-class condition. Fresh water should be allowed

ed to stand in the pump for several days, to dissolve the accumulation of salt in the housing and hose lines. Repeat this process, then pump dry. Remove drain plug in waste arm to drain any water which might remain. IF ANTI-FREEZE IS USED, IT MUST BE A GLYCOL BASE.

COMMISSIONING INSTRUCTIONS

Replace drain plug in waste arm. Be sure to check the "Joker" Valve. If the valve is stiff, it should be replaced. Proper care will assure you of a long-lasting, free-working unit.

After the boat is overboard, it is good practice to make periodic checks on waterlines, etc., to make certain all connections are tight and that valves are functioning properly.

TOILET OPERATING INSTRUCTIONS

Before Using: Raise lever and pump slowly to partly fill and wet inside of bowl.

After Using: (1) Raise lever, pump until the bowl is thoroughly cleaned and continue with several more full strokes to flush discharge lines.
(2) Depress lever and pump slowly until the bowl is empty.

IMPORTANT: When not in use, lever must be left in depressed position to prevent flooding. DO NOT PUT PAPER TOWELS, MATCHES, RAGS, ETC., into bowl. They will plug the valves.

2. STOVE

A gimbed alcohol stove is provided as standard in your Spirit 28. It incorporates the use of alcohol as a fuel. A cutting board top is utilized to cover the burners when they are not in use. The stove is gimbed so that the stove may be utilized while underway. It is "balanced" by means of an adjustable weight fastened to the underside of the stove.

SEE DIAGRAM "B" ON FOLLOWING PAGE

OPERATING INSTRUCTIONS

Before attempting to operate stove, please read these instructions care-

fully and become thoroughly familiar with the various parts of the stove and how they operate.

DIAGRAM "B"

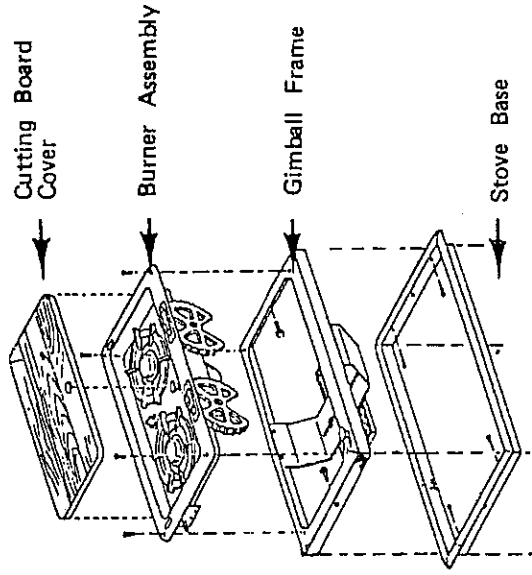

THEORY OF OPERATION

The burners use alcohol vapor for fuel. This gaseous fuel is produced by boiling liquid alcohol in the base of the burner by diverting some of the heat from the flame through the burner body.

In order to start a cold burner, it must first be heated above 189°F in order to produce the required vapor. This is usually done by turning a small amount (about ¼ oz.) of liquid alcohol in a special priming cup under the base of the burner. As the burner heats up, the liquid alcohol trapped in the burner boils, causing a flame to appear at the burner cap. If the priming cup is too full, the rising temperature also causes the priming alcohol to boil which produces a relatively high flame around the burner before it boils away. These conditions, usually termed "flare-up" are a natural consequence of the priming process and are usually not serious. A little practice will show the correct amount of alcohol necessary to produce the required temperature. Too much alcohol will produce "flare-up" and too little will not bring the burner to a high enough temperature. A hot burner will produce a hissing sound when turned on. A cold burner will be silent or produce a squirting sound, and liquid alcohol will flow

down to the priming cup. After priming, the burner must be lit before it cools off, or re-priming will be necessary.

Fuel: The burners are designed to use 95% denatured ethyl alcohol, which is commercially available as stove fuel or denatured alcohol shellac thinner. Satisfactory operation is also obtained with 91% isopropyl alcohol containing less than .003% by weight non-volatile material. **CAUTION:** Do not use wood alcohol (methanol) or rubbing alcohol as they will not burn satisfactorily and burners will become clogged.

OPERATING COMPONENTS

The fuel fill nipple is located at the rear center of the stove. Note that it has a special cap which includes a pressure relief valve which effectively prevents excessive pressure buildup in the tank. This cap must never be replaced by any other type.

DIAGRAM "C"

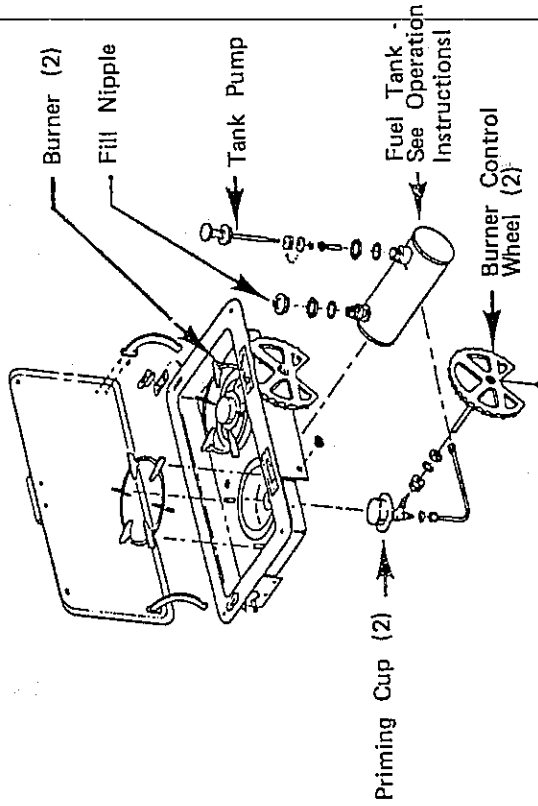

The pump is located at the front center of the stove, and is used to pressurize the fuel tank. Satisfactory operation of the alcohol burners is obtained with the fuel supplied at a pressure 8 to 15 psig. An average of 15 to 20 strokes of the pump are required to obtain sufficient pressure, but this varies depending on the amount of fuel in the tank and more strokes may provide better burner operation.

The burner control wheels are located in the front flange of the stove. The control moved to the extreme right is the "off" position. The extreme

left position, which is about six pushes of the control wheel, is the "clean" position. In this position, the internal mechanism of the burner causes a small wire to be pushed thru the burner nozzle, thereby removing any dirt which may have lodged there. The full "on" position of the control wheel is about half way between the off and clean positions, or about 3 pushes of the control wheel. The burner may be operated at lower heats by moving the control to the right toward close. Cleaning the nozzle is normally performed while the burner is operating. Move the control to the extreme left then back to the center operating position. Be prepared to relight the burner as the cleaning will often extinguish the flame.

BURNER OPERATION

Fill tank approximately $\frac{3}{4}$ full with denatured ethyl alcohol, using a funnel. Replace cap and tighten snugly.

Pump 15 to 20 times to pressurize tank.

To operate, burners must be preheated. Open the burner by moving the control three pushes to the left. This will allow liquid alcohol to flow from the burner. Close the burner after about three seconds by pushing the control back to the extreme left. About two Tbsp. of alcohol will have flowed from the burner and run down into the indentation in the cup at the base of the burner.

With the burner still off, ignite the alcohol in the priming cup.

When the priming alcohol is completely consumed, open the burner control and light the vaporized alcohol at the burner cap.

CAUTION: FLARE UP may occur during preheating and particularly if burner valve is opened before preheating is completed, and burner is not hot enough. Follow starting instructions carefully. If flare up occurs, shut off burner, allow flame to go out, then preheat again following instructions above.

Do not put cooking utensils on stove until burners are functioning properly.

When finished cooking, turn off burners and release pressure in tank by loosening filler cap.

IN CASE OF FIRE

USE WATER TO PUT OUT ALCOHOL FIRES
SMOTHER GREASE FIRES OR USE BAKING SODA
OR A CLASS B FIRE EXTINGUISHER.

HELPFUL HINTS FOR OPERATION AND MAINTENANCE OF YOUR MODEL 206 OR 209 ALCOHOL STOVE

1. To obtain maximum performance from your new stove, it is extremely important that you use a quality grade denatured (ethyl) alcohol free from impurities or 91% isopropyl alcohol stove fuel (not rubbing alcohol) containing less than .003% by weight non-volatile matter. The majority of stoves returned to us for burner service are clogged from impure alcohol.

2. A properly operating burner will have a blue flame, with several rows of little flame tips. There should not be a yellow tip on the flame. The air-fuel ratio of the burner may be adjusted for most efficient operation. With burners lit, hold burner flange with a pair of pliers and rotate flange until the yellow flame tip is eliminated, see DIAGRAM "D".

DIAGRAM "D"

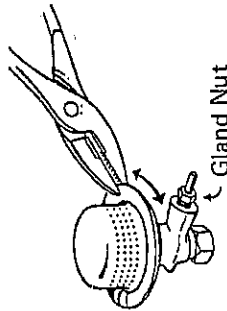

3. A burner operating properly will boil two cups of water in a 2½ qt. (6½ inch) uncovered saucepan in seven to nine minutes.

4. If you notice a small flame where the control stem enters the burner, tighten the gland nut slightly until the flame no longer appears. This adjustment may have to be made after a few hours of burner operation, but then should require very little attention. (See DIAGRAM "D")

5. If the pump bounces back when you try to pump, or if the pump handle is pushed all the way back out after a pump stroke, the check valve at the base of the pump is defective and should be replaced. (A special H-525 wrench is required to replace check valve.)

6. If you pump, and get little or no pressure in the tank, the pump U-cup needs to be replaced.

7. If the burner lights properly, but goes out after a short time, you did not pump enough, or your filler cap leaks. Replace rubber gasket or relief valve assembly.

8. If no alcohol comes thru the burner when you attempt to prime, you have no pressure in the tank, or a filter clogged by dirty alcohol.



DO NOT ATTEMPT TO FILL BURNER FLANGE -- PRIMING CUP IS BELOW BURNER BODY

DIAGRAM "E"

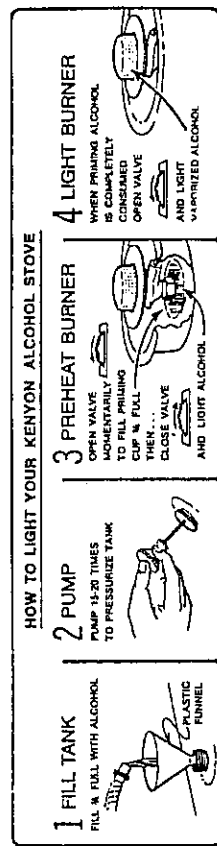

3. FUEL

The fuel system complies and meets all BIA and Coast Guard standards. It was designed to provide an accessible, safe system yielding an acceptable cruising range (i.e. approximately 18 gallon capacity).

COMPONENTS:

a.) The fuel fill is located to the port, aft end of the cockpit, outside of the cockpit proper. It is labeled either 'Gas' or 'Diesel' for the respective auxiliary.

DIAGRAM "F"

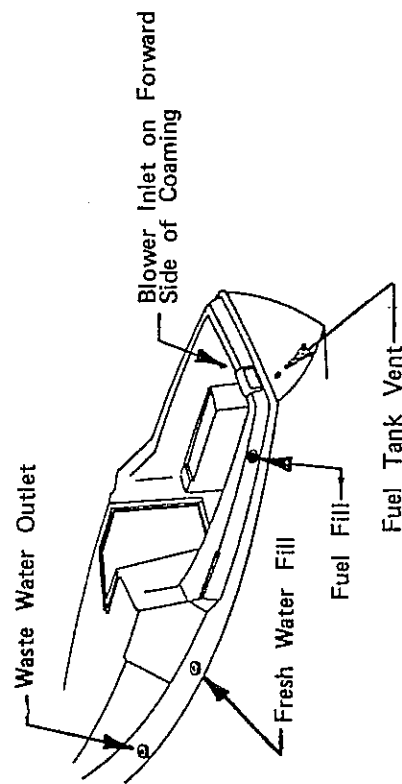

- b.) The fuel tank is an eighteen (18) gallon "aluminized" removable unit mounted to a permanent platform under the cockpit sole just aft of the auxiliary. Each tank is vented via the port transom to prevent pressure locks:

CAUTION: Please insure that the ventilation line is functioning at all times.

4. VENTILATION

The auxiliary compartment ventilation is accomplished by means of an "electric" blower mounted to the port engine compartment bulkhead. This includes diesel and gasoline auxiliaries. (The gasoline auxiliary has mechanically fastened, removable bulkheads which close in the gasoline unit, thereby preventing stray fuel vapors from escaping the compartment. The blower is activated by a toggle switch or pull switch, for gasoline and diesel respectively, located on each gauged panel mounted on the aft end of the starboard cockpit seat.

WARNING: Always operate blower five (5) minutes before starting an auxiliary and operate while running at low speeds. Inspect the system for fuel leaks frequently.

The intake for the auxiliary compartment is located in the center of the aft end of the cockpit. Insure that this vent remains free to the wind when operating the blower and/or auxiliary. Exiting of compartment air is through the port, aft exit box on the cockpit.

5. STEERING

a.) Tiller Steering

Tiller steering is a standard feature. It is provided by a laminated tiller bolted to a chromed, bronze rudder head and strap. A heavy duty stainless steel rudder shaft, permanently bonded into the fiberglass and foam rudder, is supported at the hull and deck by "Delrin" bearings on each end of a fiberglassed "PVC" tube.

DIAGRAM "G"

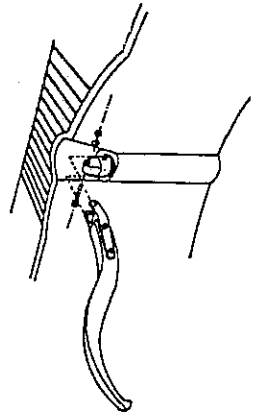

Tiller attaches with 3/8" bolt, washer and locknut. Fasten tiller snug, but not tight. Tiller should move freely up & down.

The hull bearing is permanently bonded to the hull. The deck bearing is fastened below the rudder stop immediately under the rudder head proper. Only the deck bearing is removable.

b.) Pedestal Steering

Added as an option, this unit features all engine and steering controls on one pedestal unit. **NOTE:** Should for any reason the pedestal steering fail to operate, a 12" emergency tiller has been provided which attaches to the rudder head.

DIAGRAM "H"

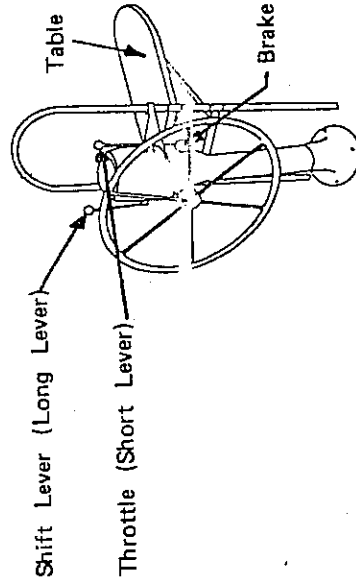

FEATURES:

BRAKE — located on the starboard side, this small chrome knob acts to "friction lock" the wheel. Turn clockwise to lock.

This feature can also be adjusted to aid in steering control in heavier seas.

CAUTION: The brake should be set to lock position when at anchor or moorage to prevent possible damage to rudder system.

ENGINE CONTROLS — These are comprised of two levers; one each located to port and starboard on the pedestal itself. The starboard control is the throttle. It accelerates by pressing forward; aft movement decelerates the auxiliary. (i.e. Some earlier diesel units, 1979 models, functioned in the reverse of the above mentioned procedure.)

NOTE: The diesel is turned off by depressing the lever past idle position (aft on 1980 models, forward on 1979 models) to cut off the fuel supply.

The key switch should be left on until the fuel supply is cut off, by the throttle, so that all audible warning systems will be functional. (See Engine Manual.)

The port control is the gearshift lever. Pressing this lever forward engages a forward direction of the yacht. Aft movement engages reverse gear.

WARNING: Never shift the transmission while the engine is running above normal idle speed as damage may result. Never start any auxiliary in gear. Always insure all parties are clear of the propeller and that the engine is in neutral before starting.

PEDESTAL GUARD — This 1" stainless tubing which surrounds the bow side of the pedestal unit, is designed to yield protection to the pedestal and to aid the helmsman and crew with a handhold.

COMPASS — This high quality lighted unit is intended to yield an aid in safe navigation. Lighting is activated by the inboard accessory switch on the main switch panel inside the cabin.

NOTE: An Aclyan cover is recommended to provide years of dependable service. The compass dome is susceptible to scratching and damage; as such, care should be exercised.

COCKPIT TABLE — A pedestal mounted "teak" table is located within the supports of the pedestal guard. It is stored in the down position for sailing and is easily lifted into the up position with its two supports slipping into the two holders on the pedestal guard itself.

NOTE: Insure that the table's supports are secure in their holders before using. This table is intended for use with a yacht in unheaved condition.

6. ELECTRICAL

CAUTION: This is a 12 volt, negative ground system. Insure that all parts not installed by the factory comply.

a.) D. C. Master Switch

This master switch controls all the electrical functions in this model. Following are the positions and explanations of each:

OFF — All electrical current is stopped at this switch. Nothing, including the engine, will operate when the switch is in this position. (When an optional electrical bilge pump is purchased, it will operate independently of the master switch.)

ONE (1) — Indicates that Battery One is switched into the boat's electrical system. All electrical components will function normally.

TWO (2) — Indicates that Battery Two is switched into the boat's electrical system. All electrical components will function normally.

BOTH — Indicates that both Battery One (1) and Two (2) are switched, in parallel, into the boat's electrical system. This position has the advantage of combining weak batteries for extra auxiliary starting power.

DIAGRAM "1"

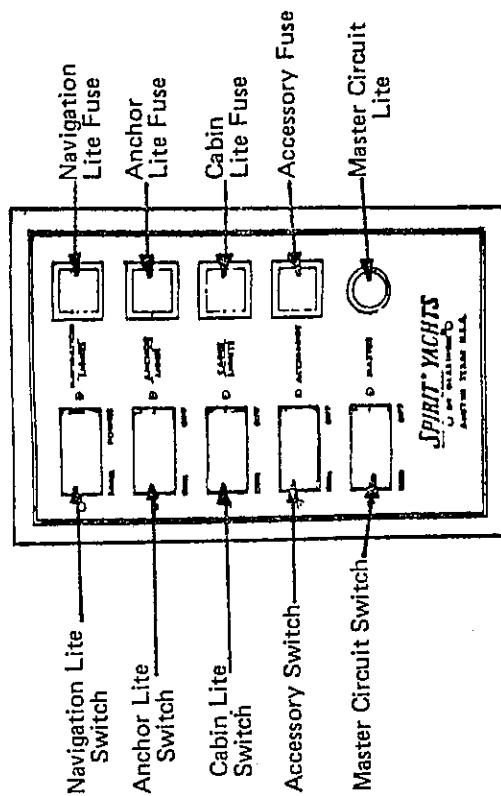

CAUTION: Never switch from one position to another while the auxiliary is running. This could result in immediate damage to the auxiliary's electrical system.

b.) Standard Instrument Panel

This panel, located on the aft galley bulkhead, includes a mixture of available switch systems and instruments necessary for proper function of your boat's electrical system.

DIAGRAM "J"

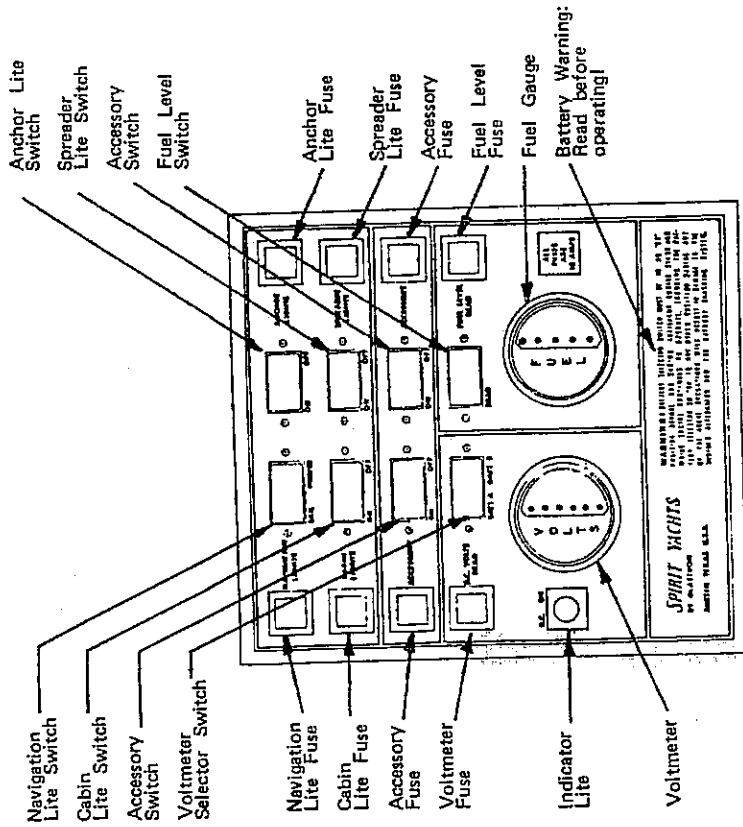

CAUTION: Replace bad fuses with the correct capacity unit only. This will prevent damage to your boat's electrical system. If a second fuse is blown, see your dealer for correction to the electrical system.

Listed below are the respective systems explanations:

NAVIGATION LIGHTS — This is a double throw switch. "Off" position is with the switch not activated to either "Sail" or "Power" positions.

SAIL — turns on the bow and stern lights. These are required for sailing in U.S. waters after sunset and before dawn. (Activation of the anchor lights in combination with the "Sail" lights will enable the 360° white mast head light to be turned on; this results in proper lighting for international waters).

POWER — Will activate bow and stern lights in combina-

tion with bow/mast light. This switch should be activated whenever powering with auxiliary after sunset and before dawn.

ANCHOR LIGHT — This single throw switch activates the 360° white mast head light. This is to be used while at anchor, or as stated above, in combination with "Sail" navigation lights for international waters.

CABIN LIGHTS — This single throw switch activates, as master switch, all cabin and engine compartment lights. Each cabin light has a separate individual switch which allows each light to be controlled on an independent basis.

SPREADER LIGHTS — This single throw switch includes complete wiring into and through the mast. Spirit Yachts does not offer the spreader lights; however, if the customer wishes to have their dealer install these lights, all wiring is already in place in the mast and deck.

ACCESSORY — There are two of these single throw switches. They are available for instrumentation hookup of radios, etc. by the dealer.

D. C. VOLT READOUT SWITCH — This is a double throw switch. Battery One (1) and Battery Two (2)'s condition may be read from this switch. It is intermittent and will not stay in either readout position unless pushed.

FUEL LEVEL — Uses a single throw switch which intermittently reads the quantity of fuel in the 18 gallon fuel tank. This gauge should only read when this switch is activated.

CAUTION: Both the fuel level and D.C. Volt switches are designed to give a readout only upon activation of a respective switch. In this manner, there is no unnecessary current drain. If one of these gauges gives a readout continuously, check to see if the respective switch is stuck in position. If not, contact your local dealer.



D.C. INDICATOR LIGHT — Indicates the D.C. master switch is turned to one of its three "On" positions; as such, the boat's electrical system has current.

c.) Optional Electrical Switch Panel

An optional panel is provided with several options installed by

Spirit Yachts. Its location is next to the main switch panel above the galley. Its several functions are listed below. Depending on which available options your particular boat is equipped with, you may have any or none of the items.

DIAGRAM "K"

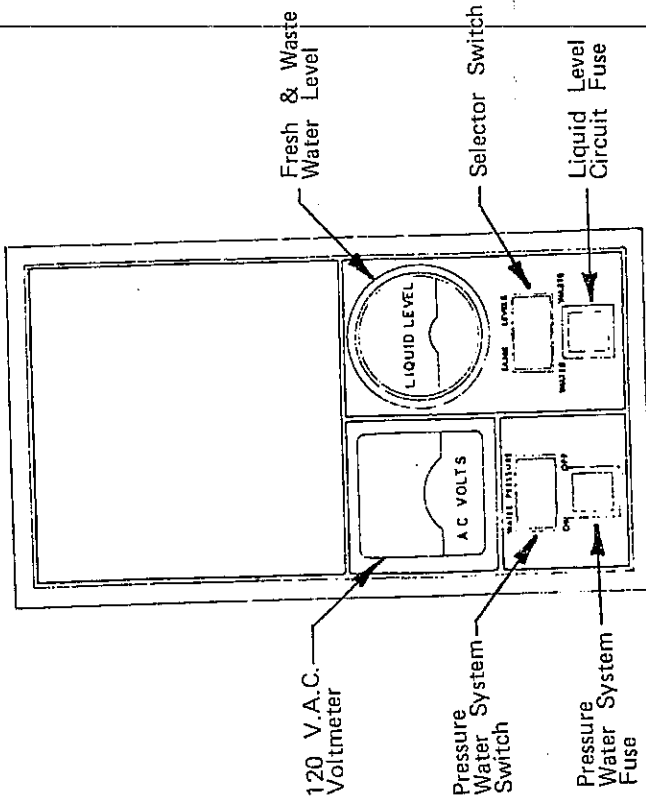

A.C. VOLT METER — Provided with shore power option. Read actual A.C. voltage from the dock or current source into which your boat's system is connected.

CAUTION: This meter is designed to provide a check on the system to enable ease of trouble shooting if a problem occurs. It also provides a quick check to the owner of proper function of the shore power system.

WARNING: It is the owner's responsibility to insure that the correct polarity is available at the dock to which they will connect their boat's system.

WATER PRESSURE SWITCH — Uses a single throw switch. When the pressurized water system is purchased (either with showers or hot water system), this switch is provided. It is the master switch which activates the pressure pump. It must be

turned on before pressure can be built up or maintained for proper function of either showers or hot water pressure sinks.

CAUTION: This switch should remain in "Off" position unless either of the above mentioned systems are needed to prevent excess current drain on batteries.

TANK LEVELS — This intermittent double throw switch provides a gauge readout of the amount of fresh water in the standard 19 gallon fresh water tank, or the quantity of waste in the 13 gallon holding tank. Therefore, it is not necessary to have a direct view of the tanks themselves to determine the quantity of liquids they contain.

d.) Mast Lights

Your Spirit 28 is provided with a wiring harness in the deck and through the mast step for proper mast wiring. A plug connector is provided which must be attached to the wiring in the mast before the mast is stepped, (see wiring diagram provided). All terminals for this connection are provided. When the mast is in the process of being stepped, this connector from the deck harness must be plugged into the mast connector. This completes the circuit on the mast lights listed below:

MAST HEAD — This 360° white light is activated by the "Anchor" Light Switch. It should be turned on when sailing in international waters or whenever at anchor

BOW LIGHT — This 180° white light is activated by the "Power" Navigation Light Switch. It should be on when running under the auxiliary at night.

SPREADER LIGHT — Spirit Yachts does not provide these units. However, all necessary wiring and the switch are included in the mast and deck. If desired, your dealer can install these units on your yacht.

e.) Cabin Lights

There are nine (9) lights in the cabin to provide good lighting conditions in all areas. (Included is one light in the engine compartment.) Each light has its own switch independent of the main system so all or only one light can be utilized at one

time. (The Main Switch on the instrument panel must be on before any cabin lights will work.)

CAUTION: Do not use more lights than necessary as excessive current drain on the ship's battery will result.

f.) Shore Power

This system is composed of: three marine grade outlets (one each on the hanging locker and galley, and one internalized in the galley); separate breakers for each outlet (located under the galley sink); a Ground Fault Interrupt Circuit Breaker (located under the galley sink); Battery Charger (absolute zero model - located behind starboard settee); Screw type waterproof Power Cord Connector (located above the starboard cockpit tee); a 25 foot Power Cord; and a Voltmeter (located at the main switch panel above the galley).

The Shore Power System incorporates several important safety features which provide an excellent system. These features are listed below:

G.F.I.C. BREAKER — This "Ground Fault Interrupt Circuit" senses grounding on any circuit and automatically shuts off the power. It is designed to prevent accidental shocks or damage to the circuits.

BREAKERS — These individual breakers, one to each outlet, can be independently controlled.

MARINE OUTLETS — All three outlets are of the highest marine grade for non-corrosive abilities.

VOLTMETER — A built-in voltmeter yields the ability to check that the correct amount of current is entering the circuits.

 **WARNING:** Always check to insure that the correct polarity is available from a dockside source. (Small polarity testers are available from electrical supply houses.)

WATERPROOF POWER CORD CONNECTOR — Provides sure connection by screwing the power cord snugly to the connector. The cap, when screwed down tight, also yields waterproof abilities when sailing.

BATTERY CHARGER — This unit provides charging to either battery, or both, depending on the position selected for the master switch, up to twelve (12) volt capacity. It will, in turn, cut off to absolute zero when the charger senses a full charge situation. As such, it may be left on continuously with the Shore Power System to yield a charged battery at all times.

 **CAUTION:** Always check to insure all electrical circuits are functioning properly before leaving a boat unattended.

g.) Mast Ground

A four (4) gauge copper multi-strand wire has been installed inside the mast support post and bolted to the mast step and keel. This ground will provide some initial protection, but in no way will it provide complete protection for passengers in the event of being struck by lightning.

 **WARNING:** Do not sail in thunderstorms or when it is probable to be struck by lightning.

7. WATER

a.) Standard

A 19 gallon fresh water tank is standard in the Spirit 28. It is a plastic tank with a 4" inspection plate, located below the port double berth in the main cabin. Filling is accomplished via a port deck mounted fill plate marked "Water". Ventilation is provided through the hull.

 **CAUTION:** Do not overfill the tank as pressure "pockets" may develop causing some minor tank leakage.

NOTE: The standard fresh water and holding tanks are removable if re-placement becomes necessary.

All fresh water lines utilize "FDA" approved nylon reinforced plastic hose.

A 24 gallon, bow mounted, fresh water tank is included with either shower or hot water option. Its functional explanation is explained under pressure water.

Manually pumped swivel/faucets are provided as standard.

These are activated by "dual action" foot pumps in either galley or head. Both faucets extend up for use by gently pulling on the faucet head; or can be stored in a down position by pressing downward.

DIAGRAM "L"

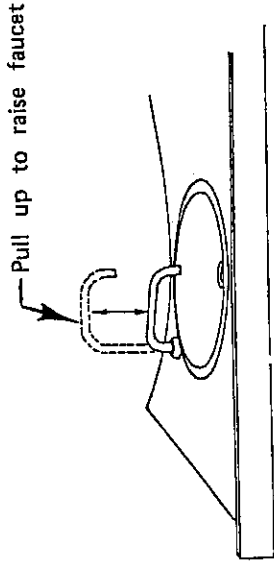

b.) Pressure Water

An internal part of the hot water options, a pressurized pump system, with accumulator tank, is located below the forward end of the quarter berth. A switch located on the optional switch panel at the galley operates this pump. It must be turned on at this switch before the system will be pressurized.

NOTE: To conserve the battery, the pressure pump should only be turned on when in actual use.

The Pressure Water System is made up of the following components:

1. Pressure Pump — (Approximately 24 P.S.I.)
2. Accumulator Tank — Helps maintain and equalize constant pressure throughout system.
3. Filter — Removes most particulate matter from fresh water tanks. (Located next to the pressure pump)
4. Bow Tank — An addition to the standard 19 gallon tank, this 24 gallon unit is mounted under the V-Berth. It fills via a deck mounted plate to the starboard of the anchor locker.
5. Shut Off Valve — A 150 PSI Ball Valve is located next to the pressure pump which acts to stop flow from the bow

tank to the main tank. As the lines are oriented to provide a direct connection between the bow and the standard tanks, this valve should be left closed, i.e. handle 90° to the valve body when both tanks are full to prevent overfilling the 19 gallon tank. When the main tank (19 gallon) runs low, this valve can be opened to provide an additional 24 gallons of fresh water.

DIAGRAM "M"

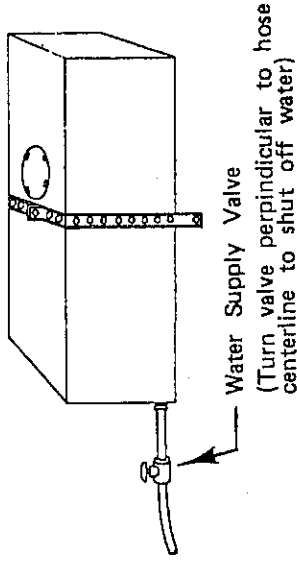

c.) Shower System

A two outlet shower system may be optionally installed. There is a cockpit shower, which exists and is stored in the port cockpit winch combing compartment; and a head shower outlet. Both units have a variable flow switch (the cockpit's unit is in the port deck cabin storage bin; the head's switch is on top of the wash basin), which alters the flow rate to the shower head. A 150 P.S.I. shut off valve is located underneath the head wash top and another behind the port settee back for each respective unit. These cut off all flow to the shower heads and prevent intermittent drops of water.

CAUTION: Care should be taken when showering inside the head module to protect stored items.

The Shower System is made up of the following components:

1. Main Shut Off Valves (2) — As above
2. Variable Flow Switches (2) — As above
3. Pressure Pump — As described in Water System Section
4. Bow Tank - 24 Gallon (1) — As described in Water System Section

5. Auto Bilge Pump — A small sump pump used to automatically pump out the keel sump. This water drains, automatically, from the head module, fiberglass shower pan. (This pump is hooked directly to the battery and will function when the master switch is off.)

d.) Hot Water System

A hot water system, optional, can be added to the above shower system to provide a total convenience package. This system utilizes a six (6) gallon pressurized water heater, hot and cold, pressurized sinks, and incorporates a few changes to the previously described shower system.

The hot water system is made up of the following components:

1. Shower Heads — The same cockpit shower system is utilized. However, with the addition of a pressurized sink in the head module, the shower is controlled by a diverter valve located on top of the faucet. This valve directs the combined hot and cold water (the head shower has both with this option) to either the sink or the shower. There is no main shut off valve in the head. Also, the cockpit unit has cold water only.

2. Water Heater — This six (6) gallon unit is pressurized and electrically heated utilizing the shore power system.

WARNING: The water heater **MUST** be full of water and pressurized (can be checked by pressing pressure relief valve located on the aft top side of the water heater; if water comes out, the heater is full) before plugging into the shore power system. Immediate damage will result to the heater unit if not full.

Once full and plugged into the plug provided, hot water should be available in ten to fifteen minutes.

WARNING: Always leave the pressure water pump turned on when using the water heater.

This provides hot water to both galley and head faucets. In turn, the head shower also provides hot water. Additionally, a salt water manual pump faucet is provided to the galley sink for 1980. It is operated by the standard dual action foot

pump. The pick up point is via a bronze sea cock located at the forward end of the engine compartment. This feature provides the additional plus of having ambient water available to the galley sink, for washing etc., without having to use from the yacht's fresh water supply.

e.) Seacocks

Bronze, quarter turn seacocks have been installed on most underwater thru-hull fittings. These include: sink drains (both galley and head), auxiliary intake (handle), marine head intake (handle) and a diverter pump exhaust (handle). All these fittings must be properly maintained for correct function. Periodically, remove and inspect the drain plugs and relubricate as per manufacturer's recommendations.

CAUTION: It is advisable to shut off all seacocks when a yacht is to be left unattended.

8. AUXILIARIES

a.) OMC Saildrive

Two engine auxiliaries are available for 1980. Standard is the OMC Saildrive, utilizing a stainless steel folding propeller. This

DIAGRAM "N"

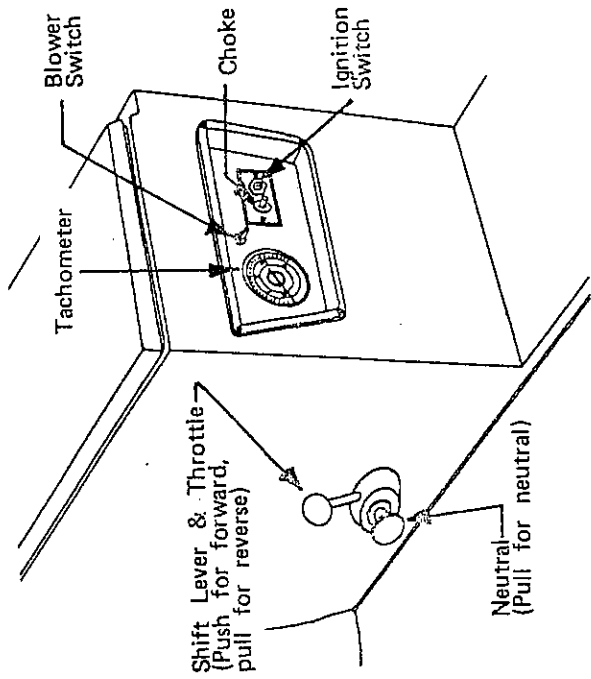

15 H.P. unit is a "two cycle" engine with a thru-hull drive unit. A gas/oil 50:1 mixture for fuel must be provided as per the manufacturer's specifications. A tachometer has been provided to yield engine running speed.

The engine controls are located on the starboard cockpit seat. It is a single lever control, with a removable handle. A "center" button, which allows acceleration of the engine without being in gear, is located in the center of this control.

See DIAGRAM "N" on Preceding Page

 **WARNING:** The blower must be operated five (5) minutes before starting this engine and while operating at low speeds. Do not block the ventilation intake and exits.

 **NOTE:** Read the manufacturer's Operation Manual completely before operating this engine.

A throttle brake has been installed on the throttle cable which adjusts the cable tension. This prevents the lever from slipping its position. (Adjustments are described in "Yanmar" section below.)

Shifting is accomplished by moving the lever, with the neutral button in, to vertical for neutral, forward for forward, and aftward for reverse.

 **WARNING:** Do not shift the engine transmission above idle speed as damage may result. Always start the auxiliary in neutral and insure that the propeller is clear and that no swimmers are in the area.

b. Yanmar 15 H.P. Diesel

The second available auxiliary is the Yanmar 15 H.P. Diesel. Its power is transmitted through the hull via a 1" bronze shaft, shaft log/packing gland, and strut. A two bland fixed bronze propeller is also standard. Electrical start is standard; however, this unit can be manually started with the hand crank provided, utilizing the procedure outlined in the manufacturer's manual.

The following are some of the components included in the Yanmar 15 H.P. Diesel.

1. Shaft Log and Packing Gland — A packing gland, which has been adjusted at the factory, is located just aft of the

diesel before the shaft exits the hull. This gland should produce approximately three drops of water every minute at 1000 RPM. This will insure proper lubrication.



 **WARNING:** Failure to properly adjust the packing gland may result in destroyed gland material. Inspect the gland material annually. Adjustment of the packing gland is accomplished by loosening the lock nut and tightening or easing the gland nut.

DIAGRAM "O"

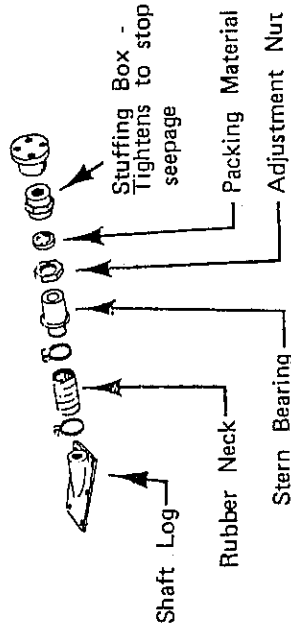

2. Strut — A "Delrin" bearing is installed inside this strut, which protects the shaft and strut. This bearing has longitudinal grooves which must remain open for proper lubrication.

 **WARNING:** Do not run shaft out of water as water is the lubricating medium.

3. Controls — A two lever control is utilized on the auxiliary. Both handles are removable by simply pulling up to unsnap them from the control box. The throttle is controlled by the smaller handle. Idle position is vertical. To accelerate, push the throttle lever forward. To stop the engine, pull the lever aftward past idle position. A throttle brake has been installed on the cable which adjusts the cable tension. This prevents the lever from slipping positions. (Adjustment is affected by loosening or tightening this bolt. It is installed on either standard or pedestal controls.

Shifting is accomplished by moving the larger lever to vertical for neutral, forward for forward and aftward for reverse.

See DIAGRAM "P" on Following Page

 **WARNING:** Do not shift the engine transmission above idle speed as

damage may result. Always start the auxiliary in neutral and insure that the propeller is clear and that no swimmers are in the area.

DIAGRAM "p"

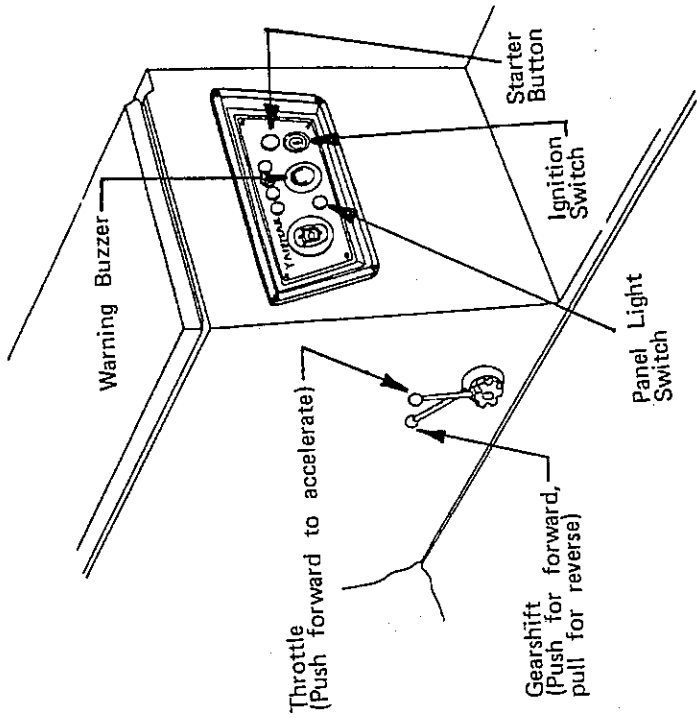

9. INTERIOR — EXTERIOR

a.) Double Berth — Main Cabin

This queen size double berth is folded into place by removing the port settee cushions. Two aluminum legs are to be folded into locked down position. The berth is then lifted from outboard, in an arc, to its down position against the cabin sole. The second cabin step must be folded up to accommodate the double berth opening and closing.

See DIAGRAM "Q" on Following Page

WARNING: Always fold the step support out under the main cabin step before using.

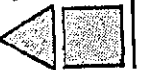

Reinstall cushions to form double berth.

DIAGRAM "Q"

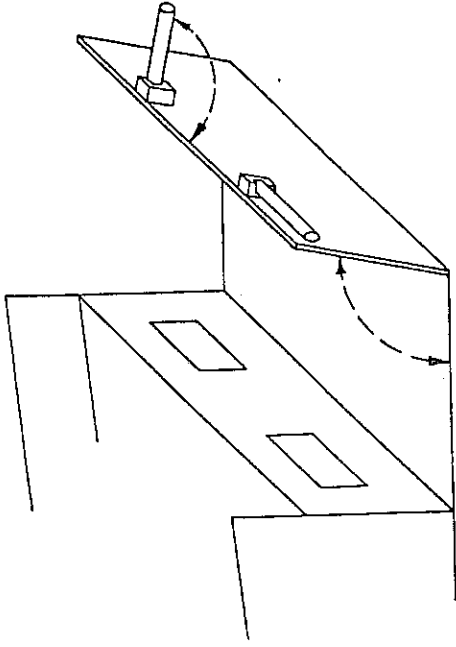

Fold out legs, then fold berth out to center of cabin.

b.) Bilge Pump — Manual

An eight (8) gallon/minute bilge pump is mounted in the starboard cockpit "tee". It incorporates a removable handle which can be stored in the cabin step tool box. The pickup is located in the aft end of the keel sump.

c.) Life Lines

Two types of life lines and pulpits, single and deluxe, are available on your Spirit 28. Single Life Lines are standard equipment. A split stern rail with boarding ladder is incorporated into this system to provide ease of entry from the water. Deluxe Life Lines are optional. This system has port and starboard amidship life line gates which may be unhooked to provide ease of entry from dockside. A split stern rail and boarding ladder are also included.

WARNING: Insure that all life lines are properly secured before getting underway. Always drop latches and snap pins in the stern ladder before getting underway.



SECTION IV: MAINTENANCE

A. FIBERGLASS CONSTRUCTION

Spirit Yacht hulls are constructed of handworked laminates of fiberglass reinforced polyester. While hand laminating is the most expensive type of fiberglass construction, we feel that it is essential to guarantee uniform construction and the best possible strength to weight ratio for your boat hull.

Glass fibers reinforce polyester resin much like steel reinforcing rods in concrete. These fibers are manufactured in three basic forms. Fiberglass cloth is much like the material in a shirt, enlarged several times. Fiberglass mat is made of short fibers pressed together into a thick sheet. Fiberglass roving is similar to fiberglass cloth, but woven with much heavier "threads."

Your boat is manufactured using a combination of these three reinforcement materials. The exterior finish of your boat is gelcoat. Even though gelcoat is the finish on the outside of the boat, it is the first material applied to the mold in the manufacturing process.

The gelcoat material used is the best and most advanced that research and industry has to offer. However, it is possible that boats which are stored in the water continuously can develop small blisters in the gelcoat. If you plan to store your boat in the water, we recommend a coating of anti-fouling paint be applied for long lasting protection. Water blistering is a common characteristic of the gelcoat surface of fiberglass laminates continuously exposed to water and will not affect the strength of your hull. Hull surface maintenance can be reduced by storing your boat out of the water.

Small hair line cracks, called gelcoat crazing, may occur occasionally in the gelcoat surface at points of impact or points of high stress. Since the gelcoat is not a structural part of your boat, this will in no way affect the performance, strength, or quality.

REPAIR

Fiberglass, as tough as it is, can be scratched, scarred, or even penetrated by hard contact with sharp objects such as spikes or jagged rocks.

Touching up scratches or blemishes is easy to do. Your dealer carries a gelcoat putty kit, color matched to your boat. Full instructions are included with each kit. If your dealer is temporarily out of the kit, he can get one for you from the factory.

B. MAINTAINING HULL FINISH

We recommend that you give your boat a coat of wax and keep the hull clean at all times. A waxed boat is easier to clean and the wax serves as a protective coating to your hardware and gelcoat finishes.

Wash your boat regularly with fresh water after use in salt water. Salt crystals will not damage your gelcoat finish but can dull the appearance. Should dirt or salt build up in the grooves or molded-in-non-skid surfaces, they can be removed with soap, water and a good brush.

If left in the water continually, (particularly in salt water) hulls are subject to many types of marine growth. These growths add weight, reduce maximum speed, and in general limit the operating efficiency of your hull. Ask your dealer to recommend an anti-fouling paint which is best for your area.

A good wax coating on a hull that does not have anti-fouling paint can make cleaning a much easier task.

We recommend that you coat your vinyl upholstery with a good grade upholstery wax. These waxes will also serve as a cleaner for soiled areas on your vinyl. The use of harsh detergents can eventually damage the threads of your vinyl upholstery parts.

Remember, when a prospective buyer looks at a used boat, he always notes the condition of the berths, vinyl and hardware as well as the finish of the hull. Keeping your boat in good condition will keep the value at its peak.

C. CARE OF SAILS

A paramount rule in making your sails live a long life is to never use a sail in wind ranges heavier than they have been designed for. Most mains and working jibs will take virtually any blast you can throw at them. Headsails, however, are a different story. Make yourself aware of each head-sail's maximum design limits and stick to them.

Do not leave your sails luff for extended periods of time, i.e., while under power, lower your sails. Luffing causes the sail fibers to chafe and break down, drastically shortening sail life.

We recommend, whenever possible, that sails be folded. We realize that this is not always possible. Rather than stuffing a wet sail in a bag, we suggest the alternative (on a cruising boat) of spreading it loosely on the cabin floor just before securing the boat after a day's sail.

SECTION V: TRAILERING 6.5/23

With a modern easy-to-launch-and-load trailer, you don't need access to private water frontage or an unlimited budget to spend on mooring facilities in order to enjoy sports afloat. You can store your Spirit Yacht in your garage or back yard.

A. CHOOSE YOUR TRAILER WITH CARE

We strongly recommend that you don't try to shave your boating budget by buying the cheapest trailer available. Trailer builders are constantly improving their products - using better metals, wheels, bearings - and standardizing on many components to relieve spare parts problems. But remember that a breakdown hundreds of miles from home may prove expensive. A trailer that is not properly mated to your boat can cause distortion or damage to the hull that may detract from its performance and prove expensive to correct.

If you expect to use a trailer merely to haul your boat to and from a permanent mooring, a mediocre piece of equipment may fill the bill. But, if you plan to store your boat for lengthy periods on the trailer and expect to travel long distances over the highways, be particular.



CAUTION: Buy only a trailer that is tagged with a specific maximum load capacity. This is a static load and represents the maximum number of pounds the trailer is designed to support at rest. This load capacity includes the weight of the boat, auxiliary motor, if any, and accessory gear. Don't exceed it. Don't merely guess at the weight. Drive an unloaded trailer to a railway, freight, or lumber yard platform scale. Weigh the trailer. Then load boat, auxiliary motor and gear - be sure to fill the auxiliary motor's fuel tank - and weigh again.

NOTICE: A copy of the latest Digest of State Boat Trailer Laws may be obtained free by writing the Boating Industry Association, 401 North Michigan Avenue, Chicago, Illinois, 60611. This complete report will tell which states require licenses, fees involved and where to apply, trailer lighting requirements, safety chain and brake requirements, maximum trailer speeds and other miscellaneous laws that may affect your tailboat travel.

B. PROPER MAST TRAILERING

When trailering your boat any long distance it is highly recommended that you purchase a mast trailering support system from your local Spirit

When the mainsail is left furled on the boom, remember to ease the outhaul. This gives the foot the same chance to relax as the hoist. This prevents distortion.

Keep your sails clean. The most frequent cause of dirty sails is dirty rigging. Industrial dirt seems to be magnetized by stainless steel shrouds. Send someone aloft periodically, with a soft cloth to wipe down the shrouds.

When sailing in salt water a fresh water rinse of your sails, whenever possible, is in order. The crystalline salt has a detrimental abrasive effect on sail cloth. You will also find your sails will dry faster minus a coating of salt.

After a few seasons of use, you may deem it necessary to give your sails a bath. We know of no laundering procedure that will return your sails to their original look. It is possible, however, to improve your sails' general appearance by washing them in mild detergent in warm water. Spot removal is accomplished by using a soft bristled scrub brush. Make sure all the detergents are removed with a thorough rinse. Do not wash in a machine. The family bathtub is far preferable.

Dry your sail, if possible, in bright sunlight. The sun's rays will contribute a bit of natural bleaching.

SPOT REMOVAL

Oil or Grease: Use commercial cleaning solvent. If a yellow stain develops, bleach with oxalic acid and rinse thoroughly.
Rust: Soak stained area in hot or warm solution of two parts hydrochloric acid per 100 parts water and rinse thoroughly.

An ounce of prevention is worth a pound of cure. Check your sails regularly for wear, particularly at the points of stress. Make sure you have your rigging properly taped to prevent sail damage. Remember, sails are like people:

1. Keep them clean.
2. Keep them dry.
3. Give them a physical once a year.

Should you have a problem with your sails, please contact our sailmaker at the address and phone number below:

ULMER SAILS
1606 1st Street
Seabrook, Texas 77586
Phone: 713/474-4168

Yachts dealer. This system will properly support your mast and will keep your mast from abrading the outer finish on your boat by keeping off the top sides of your boat.

C. TRAILER BALANCE IMPORTANT

Sway in boat trailers is usually caused by a tail heavy load. Smooth trailering calls for a 60-75 pound minimum downward pressure on the tongue. If your trailer sways, shift movable gear forward in the boat.

Sway may also be caused by an overly heavy load in the towing car. Helper springs will keep the rear of the automobile higher by compensating for added gear and trailer tongue weight.

Non-adjustable metal helper springs will prevent the towing car's rear from dipping. Pneumatic "air-lift" springs offer the added advantage of flexibility of support to meet varying load requirements, and when deflated, will prevent rough rides when your automobile is not being used for towing.

D. HOW TO RIG AND MAINTAIN YOUR TRAILER

All modern boat trailers are fitted with adjustable supporting rollers and/or bunk pads. For the protection of your boat, be certain these supports conform to the hull's design. To maintain the curvature of your boat, the bunks should run longitudinally.

A proper trailer will have a capacity of at least 600 pounds (for added gear), over the displacement of your boat. The displacements of our boats are as follows: Spirit 6.5, 2100 pounds; Spirit 23 Centerboard, 2800 pounds; and Spirit 23K, 3150 pounds. This displacement is for the standard boat, and consideration must be taken for added features plus gear, outboard motor, etc.

We recommend a bolster pad trailer over the roller trailer in that you can get better weight distribution; however, if a roller trailer is used, we recommend a minimum of 32 rollers on the trailer. These rollers must be adjusted so that they are set up as far outboard as possible.

When trailering the Spirit 23 Centerboard, it is recommended the trailer be set up so that 80% of the weight be placed on the keel trunk. Trailers for the Spirit 6.5 should be set up so as 80% of the weight is supported by the hull, and the remaining 20% by the keel. When trailering both boats, be sure to release the cable tension from the keel or centerboard.

Tie-downs should be drawn snugly so that on rough roads the boat and

its gear load remain in constant contact with the trailer bed and hull supports. We recommend carrying one extra mounted and inflated tire. Inflate trailer tires to recommended pressures, which are usually double or more than that recommended for automobile tire pressures.

Trailer wheel bearings should be greased every 2,000 miles or after use in salt water. After launching, particularly from a sandy beach or in salt water areas, flush the wheel hubs and underbody of the trailer with fresh water.

For safety, install side view mirrors on your car, since the loaded trailer may obscure your vision in the regular rear view mirror. Auto supply stores and marine dealers carry telescoping side view mirrors that may be extended when trailering.

E. TIPS ON BOAT LAUNCHING

With a present day trailer fitted with heavy duty geared retrieving winch and roller supports, you will find that handling even a 23-footer is no chore. However, since many launching ramps are rather steep, we would suggest that you carry a set of wheel chocks in your boat or towing car. Don't depend on finding stones, bricks or blocks of wood at the launching ramp.

A pair of wedge shaped wood sections fitted with a short length of chain or a lanyard will eliminate the need to crawl under the car to pull the chocks free.

If you plan to trailer to unfamiliar areas, you may find that two sections of heavy duty mesh wire, four to five feet in length and a foot wide, will prevent your car from bogging down in sandy or muddy areas. Some trailboatmen install clamp-on bumper hitches to their front bumpers. If the ground near the launching area isn't firm, uncouple and switch the boat trailer from the rear to front hitch. Then push the trailer from your car's front end to the water's edge while the car's rear wheels remain on solid ground.

If you own one of the larger Spirits, we recommend a folding wheel dolly under the tongue of the trailer.

Where launching ramps are steep, the trailer may be disconnected and rolled into position at the ramp with the aid of a dolly wheel. A spare section of cable with eye spliced fitted with "S" hooks provides a simple means to lower a trailer down a steep grade to the water while controlling it by the car's own power.

plain good practice to have a heavy duty safety chain on your trailer, capable of withstanding loads of three times the gross weight of the trailer.

CAUTION: Know and comply with state trailer laws within the area you are towing your boat. These laws vary widely from state to state.



Those who often launch from sandy beaches have learned that a portable pressurized tank-tire pump is convenient. Deflating automobile and trailer tires to approximately half their normal pressure will prevent them from bogging down. The air tank accessory will save the back and arm strain of hand pumping and will eliminate even short distance travel to the nearest service station on under-inflated tires.

Periodically lubricate winch bearing surfaces, rollers, components of the ball and socket coupler and other swiveling or hinged components such as rear cradle linkage.

F. STORING YOUR BOAT ON A TRAILER

There is no one right way to store a boat. Water offers the perfect cradling to prevent boat distortions, but mooring afloat has the drawback of exposure. When mooring at home, with the boat on the trailer, keep your rig in a protected location, shaded and preferably under cover. Remove wet gear from the boat. Loosen tie-down lines. Be certain that the trailer bed offers good support at the keel. Protect boat from corrosive elements or salt atmosphere and periodically wash down the boat.

Remember that interior vinyls, even though very durable, can be damaged by exposure to extreme weather conditions.

Plexiglass windows should be flushed with fresh water and soap, dried with a chamois and covered from direct sunlight. For off-season trailer storage, jack the trailer axles so the wheels are free of the ground, then put cement blocks or some other chocking material under the trailer axle so the wheels don't rest in mud, damp grass, snow or ice.

Use A Sturdy Frame Hitch

We strongly recommend, even for short distance trailing, that you fit the towing car with a frame-type hitch, bolted or welded securely to your car's frame.

CAUTION: Check the ball hitch for secure latching before towing trailer from parked position.



Many modern automobiles are built with very lightweight frame material. Consult your marine dealer or local mechanic and follow his advice if he recommends having additional stressing metal added for greater security. A modest-priced welding job will assure you that your trailer won't break free due to a faulty hitch and damage your boating equipment or cause

SECTION VI: WARRANTY

WARRANTY CLAIMS

To make a claim under warranty, contact the authorized Spirit Yachts dealer from whom the boat was originally purchased, or the nearest authorized Spirit Yachts dealer. Remember, your boat must be delivered to an authorized Spirit Yachts dealer within the warranty period, and all work must be performed by an authorized Spirit Yachts dealer. Any repairs to be performed after the warranty period must first be approved in writing by the Spirit Yachts Customer Relations Department. Proof of purchase will be required by the Spirit Yachts dealer to substantiate any warranty claim.

EXAMPLES OF ITEMS NOT COVERED BY WARRANTY:

Provisions of the warranty will not apply to:

1. Normal service requirements arising during the warranty period.
2. Normal service work over and above the repair and replacement of defective parts.
3. Boats subject to misuse, neglect, negligence, accident, or used for racing purposes.
4. Boats that have been altered or modified so as to adversely affect their operation, performance or durability, or to change their intended use.
5. Non-structural cosmetic defects such as bubbles or crazes (hairline cracks) in the gelcoat (outer surface).
6. Repairs made necessary by the use of parts of accessories which are either incompatible with the boat or adversely affect its operation, performance or durability.
7. Boats not operated or maintained in accordance with the instructions in the SPIRIT YACHT'S Owner's-Operator's Manual.
8. Expense of returning the boat to the dealer and expense of returning the boat back to the owner, removal of the motor from a boat and re-installation, repairman's travel time, and in-and-out-of-the-water charges.
9. This warranty applies only to the original retail purchase.

OWNER'S OBLIGATION AND RESPONSIBILITY

Normal maintenance service and replacement of service items are the responsibility of the owner and as such are not considered defects in material or workmanship within the terms of the warranty. Individual operating habits and usage contribute to the need for maintenance service. To assist you in obtaining maximum service and satisfaction from your new Spirit Yacht the principal service and replacement items are described as follows:

PROPER MAINTENANCE AND CARE: See your Spirit Yachts dealer for proper maintenance and care of your boat. Proper maintenance and care will assist in keeping your overall operating cost at a minimum.

BOAT MAINTENANCE: (See Boat Owner's Manual)

PROPER TRAILERING, CRADLING & MOORING

WARRANTY

"All Spirit Yachts, Division of Glastron Boat Company, warranties are LIMITED WARRANTIES within the meaning of Title 1 of the Federal Trade Commission Improvement Act."

MANUFACTURER'S WARRANTY AND DISCLAIMER

Spirit Yachts warrants to the original purchaser only, each new Spirit sailboat hull and deck to be free of defects in material and workmanship under normal use or service for a period of one (1) year from the date of retail purchase from an authorized Spirit Yachts Dealer according to the following terms:

Any part of the Spirit sailboat manufactured by Spirit Yachts found in the reasonable judgment of Spirit Yachts to be defective in material or workmanship will be repaired or replaced at Spirit Yachts' option by an authorized Spirit Yachts Dealer, or at the Spirit Yachts factory. There will be no charge for parts and labor, provided the factory or any authorized Spirit Yachts Dealer is notified within thirty (30) days of defect. Transportation expense of delivering the boat or part to the Dealer or the Spirit Yachts factory and expense of returning the boat back to the owner will be paid for by the owner. Proof of purchase will be required to substantiate any warranty claim. All warranty work must be authorized by a Spirit Yachts Factory Representative; and only authorized Spirit Yachts Dealers or the factory can perform warranty work.

ITEMS NOT COVERED BY WARRANTY

This warranty does not apply to: (1) mast, engines, controls, batteries, or other equipment or accessories which are not manufactured by Spirit Yachts, and which carry their own individual manufacturer warranties; (2) machinery, equipment and accessories not factory installed; (3) non-structural cosmetic defects such as bubbles or crazes (hairline cracks) in the gelcoat (outer surface); (4) any Spirit sailboat which has been altered, subject to misuse, negligence or accident; (5) any Spirit sailboat used for commercial purposes. Upon request, Spirit Yachts may provide special written warranty for specific commercial applications.

In addition, this warranty does not extend to repairs made necessary by normal wear, or by the use of parts or accessories which, in the reasonable judgment of Spirit Yachts are either incompatible with the boat or adversely affect its operation, performance or durability. Personal flotation devices should be carried for each passenger in accordance with the U.S. Coast Guard requirement.

NO OTHER WARRANTIES MADE: Liability Disclaimer

Repairs or replacement qualifying under this warranty will be performed in accordance with the terms stated herein. Spirit Yachts' responsibility in respect to claims is limited to making the required repairs or replacements, and no claim of breach of warranty shall be cause for cancellation or rescission of the contract of sale of any boat.

Spirit Yachts assumes no responsibility for loss of use of the boat, loss of time, inconvenience, or other damage, consequential or otherwise, including, but not limited to, expense for gasoline, expense of returning the boat to the dealer and expense of returning the boat back to the owner, removal of the motor from a boat and reinstallation, mechanic's travel time, in-and-out-of-water charges, rental of another boat during the time warranty repairs are being performed, travel, lodging, loss or damage to personal property, or loss of revenue.

Spirit Yachts reserves the right to change or improve the design of any boat without assuming any obligation to modify any boat previously manufactured.

ALL IMPLIED WARRANTIES ARE LIMITED IN DURATION TO THE DURATION OF THE ONE (1) YEAR WARRANTY PERIOD. ACCORDINGLY, ANY SUCH IMPLIED WARRANTIES INCLUDING MERCHANTABILITY, FITNESS FOR A PARTICULAR PURPOSE, OR OTHERWISE; ARE DISCLAIMED IN THEIR ENTIRETY AFTER THE EXPIRATION OF THE ONE (1) YEAR WARRANTY PERIOD. SPIRIT

YACHTS' OBLIGATION UNDER THIS WARRANTY IS STRICTLY AND EXCLUSIVELY LIMITED TO THE REPAIR OR REPLACEMENT OF DEFECTIVE PARTS, AND SPIRIT YACHTS DOES NOT ASSUME OR AUTHORIZE ANYONE TO ASSUME FOR THEM ANY OTHER OBLIGATION.

Some states do not allow limitations on how long an implied warranty lasts and some states do not allow the exclusion or limitation of incidental or consequential damages, so the above limitations and exclusions may not apply to you.

This warranty gives you specific legal rights, and you may also have other rights which vary from state to state.

This warranty applies only to boats sold in the United States and Canada. In keeping with Spirit Yachts' policy of continuous improvement of all products, we reserve the right to change specifications and prices without notice.

CAUTIONS SUMMARIZED

The purpose of the warning and caution notices is to attract the operator's attention to possible dangers. Each deserves the operator's special attention and understanding. Safety warnings do not by themselves eliminate any danger, and the warnings they give are not substitutes for proper accident prevention measures.

TO THE BEGINNING SAILOR: This manual presumes that certain sailing basics will have been learned before taking out your SPIRIT YACHT for the first time. Sailing is a wonderful family recreation, and an exciting sport. As with any boating activity, there are common hazards which must be learned through training and experience. Never attempt to learn to sail "on your own."

SPECIAL NOTE: A "Phillips" screwdriver is an especially important piece of equipment — it can be used to operate the auxiliary engine controls (Spirit 28 only) in the event the removable control handles are lost or misplaced.

NOTE: If you carry fuel for an auxiliary motor, you should carry a fire extinguisher. However, due to the danger of toxic fumes, vaporizing liquid extinguishers are not recommended. Dry chemical, carbon dioxide, or foam extinguishers are best.

CAUTION: Before launch, make sure the hose is on all Seacocks or that the valves are closed.

CAUTION: Check that boat is properly equipped with U.S. Coast Guard required and approved safety equipment.

You must have U.S.C.G. approved personal flotation devices for each person on board. These should be readily available when there is a threat of a storm or when navigating on dangerously rough water.

Small children and non-swimmers should be required to wear flotation devices at all times.

WARNING: Do not screw the locking bolt in while the keel is in the up position, otherwise damage can be done when lowering the keel.

CAUTION: On either the S-6.5 or S-23CB, damage can occur if the keel or center board respectively is raised too far, or if it is raised or lowered out of water.

WARNING: Do not overtighten centerboard cable past full up position.

CAUTION: Do NOT attempt to unstep mast while the pop top is still bolted to the mast.

CAUTION: The pop top is not designed to support the full weight of a person. DO NOT SIT ON THE POP TOP.

CAUTION: Observe the following cautions when using the Pop Top.

1. Do not allow fingers or hands near the contact edges between top and deck when raising or lowering the top.
2. Always attach safety hook to mast when the top is in open position.
3. Always have a firm grip on top when opening or closing. The pop top has considerable weight, and therefore care must be taken when raising or lowering it.
4. Do not lift top by the main sliding hatch. The main hatch was not designed to lift the top.
5. Always close the top during high winds or rough conditions.
6. Do not sail while pop top is in an up position.

CAUTION: Avoid sudden quick movement of tiller when rudder is in up position as damage to rudder head or blade may result.

CAUTION: Sailing in shoal waters with rope cleated by clam cleat will result in damage to rudder upon striking submerged, solid objects.

CAUTION: Swim only in known waters, when the boat is securely anchored. Keep one person, who understands the operation of the boat, on board at all times.

The mast light wiring attaches to the boat wiring through a plug located just forward of the mast step. **CAUTION:** This plug is to be disconnected before unstepping the mast.

WARNING: Make sure that both legs of the folding berth are down and snapped in place before using.

CAUTION: Always install the correct amount of chemical treatment to any holding tank before use.

DO NOT put oil, kerosene, gasoline or alcohol in the toilet bowl or pump. They will ruin the valves.

Fuel: The stove burners are designed to use 95% denatured ethyl alcohol, which is commercially available as stove fuel or denatured alcohol shellac thinner. **CAUTION:** Do not use wood alcohol (methanol) or rubbing alcohol as they will not burn satisfactorily and burners will become clogged.

CAUTION: FLARE UP may occur during preheating and particularly if burner valve is opened before preheating is completed, and burner is not hot enough. Follow starting instructions carefully. If flare up occurs, shut off burner, allow flame to go out, then preheat again following instructions.